

Robustness of synchronization in coupled Chua's circuits

G. Q. Zhong, K. T. Ko and K. F. Man
 Department of Electronic Engineering
 City University of Hong Kong
 Kowloon, Hong Kong
 China
 eegzhong@cityu.edu.hk

Abstract— This paper addresses the robustness in synchronization by perturbing the system parameters. Both mutually and unidirectionally coupled Chua's circuits have been used for this investigation. The results obtained from numerical computation have been found that the coupled systems is in its most robust form when the state variable x only is used for coupling, whereas the state variable z is found to be otherwise. This paper reports a thorough investigation into the effectiveness of the parametric variations and a number of critical regions have been defined for the classification of the chaos within the context of synchronization.

I. INTRODUCTION

Synchronization of chaos is a fundamental technique for engineering and technical applications, such as secure communications. The study in this area is recently extensive. Despite of the basic property of chaotic behavior, the concept of synchronization is to couple two (or more) chaotic systems, in such a way that their common signals are asymptotically identical [1]-[2].

To construct such a set of coupled chaotic systems, a variety of approaches using the well known Chua's circuits have been recently reported in literatures [3]-[4]. Indeed, it has been reported in [3] that the synchronization between two identical Chua's circuits can be achieved in both mutual and unidirectional coupling manner. It has also indicated that the coupling effect is not state variable dependent, although any combination of the three state variables, or even only one state variable, is enough for the synchronization to take place.

However, it is difficult to build two *identical physical* Chua's circuits because of the tolerance and the time-variant property of components. In this paper, we shall investigate their robustness during the process of synchronization by assessing the drift in parametric values. The method of assessment can be made by the common use of phase plot, which also known as *Lissajous Figure*, instead of calculating the *Conditional Lyapunov Exponents* (CLE). In some cases, it has been shown in [3] that the synchronization can be reached even when the CLE values are not all negative. Whereas for the phase plot, the synchronization can be accurately demonstrated by the appearance of a straight line. In this way, the performance of the synchronization can thus be vividly verified.

This paper is organized as follows: The model of basic Chua's circuit for the study is introduced in Section II. The robustness of synchronization in the system of two mutually-coupled identical Chua's circuits

G. Q. Zhong is on leave from Guangzhou Institute of Electronic Technology, Academia Sinica, Guangzhou 510070, People's Republic of China.

against the drifts of parameter values is investigated in Section III. The similar examination for the system of two unidirectionally-coupled identical Chua's circuits is carried out in Section IV. Some remarks about the robustness of synchronization in the systems of coupled Chua's circuits are concluded in Section V.

II. MODEL OF CHUA'S CIRCUIT

Chua's circuit, as shown in Fig. 1(a), is a simple electronic circuit consisting of a linear inductor L , a linear resistor R , two linear capacitors C_1 and C_2 , and a nonlinear resistor N_R yet it exhibits the complex dynamics of bifurcation and chaos. Since its discovery in 1983 [6]-[8], the Chua's circuit has become a universal paradigm for the study of chaos [9]. The dynamical behavior of the circuit is governed by the following state equations [10]:

$$\left. \begin{aligned} C_1 \frac{dv_{C_1}}{dt} &= \frac{1}{R}(v_{C_2} - v_{C_1}) - g(v_{C_1}) \\ C_2 \frac{dv_{C_2}}{dt} &= \frac{1}{R}(v_{C_1} - v_{C_2}) + i_L \\ L \frac{di_L}{dt} &= -v_{C_2} \end{aligned} \right\} \quad (1)$$

where v_{C_1} and v_{C_2} are the voltages across the capacitors C_1 and C_2 , respectively; i_L is the current flowing through the inductor L ; and $g(\cdot)$ is the $v-i$ characteristic of the nonlinear resistor N_R which is defined as:

$$g(v_R) = G_b v_R + \frac{1}{2}(G_a - G_b)[|v_R + B_p| - |v_R - B_p|] \quad (2)$$

where G_a and G_b represent the slopes of the inner and outer regions of $v-i$ characteristic, respectively, B_p is the breakpoint of the piecewise-linear curve shown in Fig. 1(b).

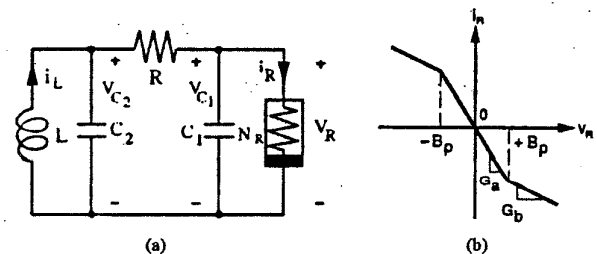

Fig. 1. (a) Chua's circuit (b) $v-i$ characteristic of nonlinear resistor N_R

For simplicity, we use the dimensionless state equations to represent the Chua's circuit [3]. Its rescaled parameters for our investigation are as follows: $x \triangleq v_{C_1}/B_p$, $y \triangleq v_{C_2}/B_p$, $z \triangleq i_L R/(B_p)$, $\tau \triangleq t/RC_2$, $a \triangleq RG_a$, $b \triangleq RG_b$, $\alpha \triangleq C_2/C_1$, $\beta \triangleq C_2 R^2/L$.

Hence, the normalized system equations are:

$$\left. \begin{aligned} \dot{x} &= \alpha(y - x - f(x)) \\ \dot{y} &= x - y + z \\ \dot{z} &= -\beta y \end{aligned} \right\} \quad (3)$$

where

$$f(x) = bx + \frac{1}{2}(a - b)[|x + 1| - |x - 1|] \quad (4)$$

$$\dot{x} = \frac{dx}{d\tau}, \dot{y} = \frac{dy}{d\tau}, \text{ and } \dot{z} = \frac{dz}{d\tau}.$$

We also choose and fix the following parameter values of the Chua's circuits, and the initial conditions (0.01, 0.01, 0.001; 0.1, 0.1, 0.001) for the system throughout our investigation so that the Chua's circuit exhibits a *Double-Scroll attractor* [3]: $C_1 = 10nF, C_2 = 100nF, L = 18.75mH, G = 0.599mS, B_p = 1V, G_a = -0.76mS, G_b = -0.41mS$; or in their dimensionless form: $\alpha = 10, \beta = 14.87, a = -1.27, b = -0.68$.

III. SYNCHRONIZATION IN MUTUALLY-COUPLED CHUA'S CIRCUITS

Consider a set of two identical Chua's circuits $\{x, y, z, \tilde{x}, \tilde{y}, \tilde{z}\}$ to be mutually coupled by the linear resistors R_c , as shown in Fig. 2 (z -coupled route is hidden in the diagram), whose parameters are identical as those listed in Section II. This coupled system can be expressed by the following state equations:

$$\left. \begin{aligned} \dot{x} &= \alpha(y - x - f(x)) + k_x(\tilde{x} - x) \\ \dot{y} &= x - y + z + k_y(\tilde{y} - y) \\ \dot{z} &= -\beta y + k_z(\tilde{z} - z) \\ \dot{\tilde{x}} &= (\alpha + \Delta\alpha)(\tilde{y} - \tilde{x} - f(\tilde{x})) + k_x(x - \tilde{x}) \\ \dot{\tilde{y}} &= \tilde{x} - \tilde{y} + \tilde{z} + k_y(y - \tilde{y}) \\ \dot{\tilde{z}} &= -(\beta + \Delta\beta)\tilde{y} + k_z(z - \tilde{z}) \end{aligned} \right\} \quad (5)$$

where

$$f(x) = bx + \frac{1}{2}(a - b)[|x + 1| - |x - 1|] \quad (6)$$

$$f(\tilde{x}) = (b + \Delta b)\tilde{x} + \frac{1}{2}((a + \Delta a) - (b + \Delta b))[|\tilde{x} + 1| - |\tilde{x} - 1|] \quad (7)$$

and k_x, k_y and k_z are the coupling factors, $\Delta\alpha, \Delta\beta, \Delta a$ and Δb are the perturbations of the parameters α, β, a and b , respectively.

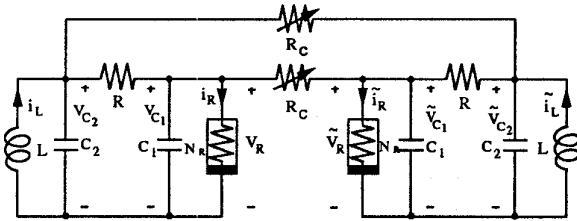

Fig. 2. Circuit diagram of two identical Chua's circuits x, y, z mutually coupled (z -coupling route not indicated).

For a complete coupled system, we assume that the coupling factors have identical positive values, i.e., $k_x = k_y = k_z = \delta > 0$. However, should the system be coupled using less than three state variables, the coupling

factor associated with the uncoupled state variable is zero.

Obviously, the synchronization is dependent on the coupling factors $k_j (j = x, y, z)$ and the initial conditions, as reported in [11]. It has also indicated that there establishes a set of *critical values* $k_j (j = x, y, z) = \delta^*$, of which the synchronization is ensured only when all $\delta > \delta^*$, except for the coupling of state variable z . In this case, a confirmed boundary region is existed for the coupling factors that enables the system to be driven into synchronization.

A. Robustness of synchronization against drifts of α and β

In this paper, we address another important issue. That is the robustness in synchronization based on the development of Chua's circuit. In the past, the study in this area assumed only identical Chua's circuits for coupling. However, in practice, two identical Chua's circuits are not possible as the tolerance and time-variant property of the electronic components. A slight mismatch could lead the coupled Chua's circuits from synchronization into the various mode of abnormal behaviors, such as sub-synchronization, asynchronization and blow-up.

Therefore to enhance the quality of synchronization, this subsection is to investigate the robustness of synchronization in the coupled system based on the parametric drift $\Delta\alpha$ and $\Delta\beta$. Here, we consider a variation of 20 percent for $\Delta\alpha$ and 10 percent for $\Delta\beta$. The perturbation is operated from the nominal values of $\alpha = 10$ and $\beta = 14.87$ as indicated in Section II, where the conditions for forming a Double-Scroll attractor are clearly stated. In the mean while Δa and Δb in (7) are set to be zero.

Furthermore, to allow a large variation in perturbation, the coupling factors are also set to five times of the critical values [11], i.e., $\delta = 5\delta^*$, while a mid-range value for k_z is adopted for the z -coupled system.

A total of seven cases of studies have been investigated and the results are summarized as shown in Fig. 3 with the corresponding coupling factors tabulated in Table I.

TABLE I
PERFORMANCE AGAINST DRIFTS OF α AND β IN COUPLED SYSTEM

Case	k_x	k_y	k_z	Behavior
1	0.95	0.95	0.95	Fig. 3(a)
2	2.05	2.05	0	Fig. 3(b)
3	1.6	0	1.6	Fig. 3(c)
4	0	1.3	1.3	Fig. 3(d)
5	16.1	0	0	Fig. 3(e)
6	0	3	0	Fig. 3(f)
7	0	0	0.61	Fig. 3(g)

As indicated from Fig. 3, the variations $\Delta\alpha$ and $\Delta\beta$ could lead the coupled system into various mode of behaviors. In fact, the results have also shown that there

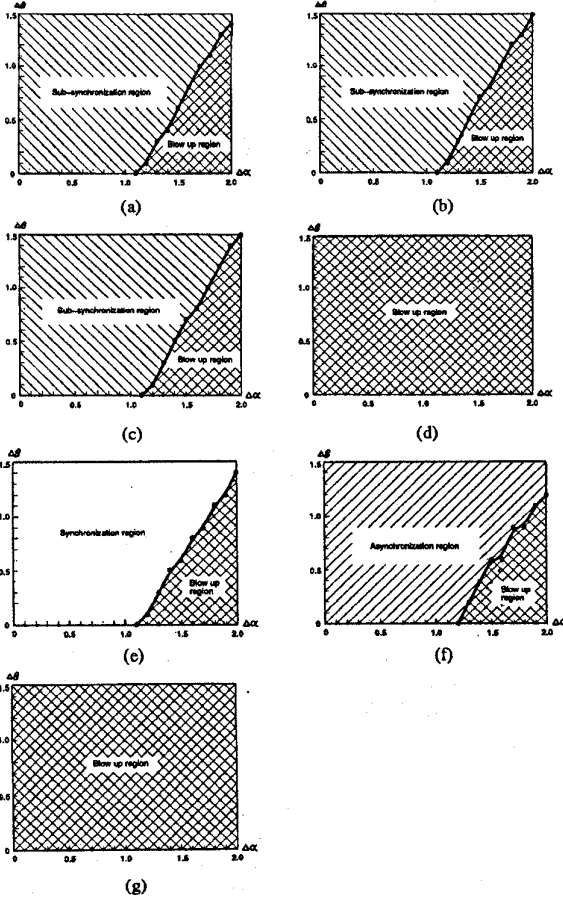

Fig. 3. Performance of synchronization against the drifts of α and β in two mutually coupled Chua's circuits. Blank region is in synchronization mode, backslashed regions are in sub-synchronization mode, slashed region is in asynchronization mode, and mesh regions are in blow-up. Vertical axis: $\Delta\beta$, Horizontal axis: $\Delta\alpha$. Parameter values are listed in Table I.

are four distinct mode of behaviors which can be caused by the perturbation in α and β :

1) *Synchronization Region*: When the system is synchronized, the phase plot for the two corresponding state variables should exhibit a fine straight line, as shown in Fig. 4(a).

2) *Sub-synchronization Region*: A weak synchronization phenomenon is observed in the sense that the trajectories are mostly tracking with some phase error. Hence, the phase plot for the two corresponding variables looks like a stretched oval as shown in Fig. 4(b).

3) *Asynchronization region*: The system is no longer synchronized, and the phase plot for the two corresponding variables has a complicated structure, as shown in Fig. 4(c).

4) *Blow-up Region*: The trajectory is no longer a Double Scroll attractor; it diverges and becomes a large limit cycle due to the eventual passivity.

Hence, based on these classifications, it can be noted from Fig. 3 that the robustness in synchronization for variations of $\Delta\alpha$ and $\Delta\beta$ can be summarized as follows:

1. a robust system exists when the state variable x only is coupled, see Fig. 3(e);

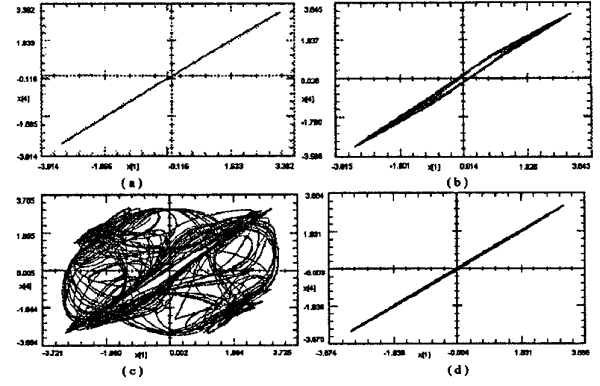

Fig. 4. Phase plot for two corresponding state variables of two coupled Chua's circuits. Vertical axis: \tilde{x} , Horizontal axis: x . Parameter values: (a) $k_x = 16.1, k_y = k_x = 0, \Delta\alpha = 0.5, \Delta\beta = 1.0$ (synchronization); (b) $k_x = k_y = 2.05, k_x = 0, \Delta\alpha = 1.1, \Delta\beta = 0$ (sub-synchronization); (c) $k_x = k_x = 0, k_y = 3, \Delta\alpha = 1.2, \Delta\beta = 0$ (asynchronization); (d) $k_x = k_y = 4.25, k_x = 0, \Delta\alpha = \Delta\beta = 0.5$ (almost synchronization).

2. any other combination of couplings, whether it is a single state variable z, y , or the combination among z, y , and x , the synchronization is fragile, particularly when the state variable x coupling is neglected. These can be clearly shown in Figs. 3(d), (f), and (g), respectively; and

3. the effect of variation in $\Delta\beta$ is found to be less important to the x -coupled system, see Figs. 3(a)-(c) and (e). Furthermore, any change in $\Delta\beta$ is somewhat counteracting the effect of the $\Delta\alpha$.

B. Robustness of synchronization against drifts of a and b

Apart from the α and β , the behavior of Chua's circuit depends also upon the parameters a and b as expressed in (4). Therefore, a similar treatment was conducted for assessing the robustness in synchronization against the drifts of a and b . In this case, the maximum drifts considered for both Δa and Δb are 10 percent of the nominal a and b , respectively. Meanwhile, $\Delta\alpha$ and $\Delta\beta$ in (5) are set to be zero. The coupling factors used for the seven cases remain the same as those listed in Table I.

The results obtained are illustrated in Fig. 5 and can be classified as shown in Table II.

TABLE II
PERFORMANCE OF SYNCHRONIZATION AGAINST DRAFTS OF a AND b IN COUPLED SYSTEM

Case	Mode	Figure
5	Synchronization	5(b)
1,2,3	Sub-synchronization	5(a)
6	Asynchronization	5(c)
4,7	Blow-up	5(d)

It can be seen from both Fig. 5 and Table II that only the x -coupled system will ensure synchronization with respect to the changes in both a and b . For any

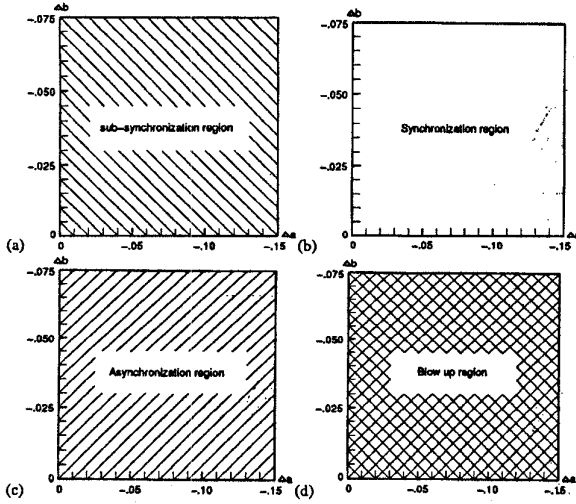

Fig. 5. Performance of synchronization against the drifts of a and b in two mutually coupled Chua's circuits. Blank region is in synchronization mode, backslashed region is in sub-synchronization mode, slashed region is in asynchronization mode, and mesh region is in blow-up. Vertical axis: Δb , Horizontal axis: Δa . Parameter values are listed in Table I and II.

other state variable coupling without the participation of x variable, the changes in both a and b are extremely sensitive to the process of synchronization, which could cause the system to be in the mode of asynchronization and even blow up, as shown in Figs. 5(c) and (d).

IV. SYNCHRONIZATION IN UNIDIRECTIONALLY-COUPLED CHUA'S CIRCUITS

In this section, we examine the synchronization in the system of two identical Chua's circuits unidirectionally coupled, as shown in Fig. 6. The state equations describing this system are the same as (5)–(7), but the terms with k_j ($j = x, y, z$) are missing in the subsystem $\{\tilde{x}, \tilde{y}, \tilde{z}\}$, i.e.:

$$\left. \begin{aligned} \dot{\tilde{x}} &= \alpha(y - x - f(x)) + k_x(\tilde{x} - x) \\ \dot{\tilde{y}} &= x - y + z + k_y(\tilde{y} - y) \\ \dot{\tilde{z}} &= -\beta y + k_z(\tilde{z} - z) \\ \dot{\tilde{x}} &= (\alpha + \Delta\alpha)(\tilde{y} - \tilde{x} - f(\tilde{x})) \\ \dot{\tilde{y}} &= \tilde{x} - \tilde{y} + \tilde{z} \\ \dot{\tilde{z}} &= -(\beta + \Delta\beta)y \end{aligned} \right\} \quad (8)$$

where

$$f(x) = bx + \frac{1}{2}(\alpha - b)[|x + 1| - |x - 1|] \quad (9)$$

and

$$f(\tilde{x}) = (b + \Delta b)\tilde{x} + \frac{1}{2}((\alpha + \Delta\alpha) - (b + \Delta b))[|\tilde{x} + 1| - |\tilde{x} - 1|] \quad (10)$$

The selection for the coupling factors k_j ($j = x, y, z$) is the same as that mentioned in Section III.

To examine the robustness of synchronization against drifts in α, β, a and b , similar treatment for the investigations as those mentioned in Section III will remain unchanged. But the coupling factors as tabulated in

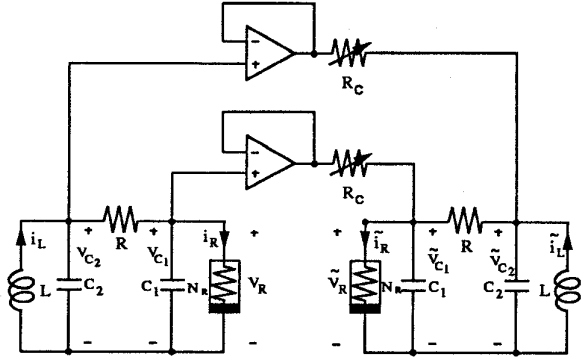

Fig. 6. Circuit diagram of two x, y, z unidirectionally coupled identical Chua's circuits (z -coupling route not indicated).

TABLE III
PERFORMANCE OF SYNCHRONIZATION AGAINST DRIFTS OF α AND β IN MASTER-SLAVE SYSTEM

Case	k_x	k_y	k_z	Behavior
1	2.0	2.0	2.0	Fig. 7(a)
2	4.25	4.25	0	Fig. 7(b)
3	3.35	0	3.35	Fig. 7(c)
4	0	2.45	2.45	Fig. 7(d)
5	32.5	0	0	Fig. 7(e)
6	0	6.5	0	Fig. 7(f)
7	0	0	2.0	Fig. 7(g)

Table III are selected for the examination. The performances of synchronization against the drifts of α and β observed are presented in Figs. 7(a)–(g).

From the results shown in Fig. 7 and Table III, we can note that the most robust synchronization against the changes in α and β is found when the state variable x only is coupled, see Fig. 7(e). On the other hand, the system is extremely sensitive to the parameter mismatch when the state variable x is omitted from coupling in any form. It can be seen from Figs. 7(d), (f) and (g) that the tolerance of drifts $\Delta\alpha$ and $\Delta\beta$ are very small for the synchronization in such a system.

It should be noted from Figs. 7(a–c) that an “Almost Synchronization” region is existed. The performance in this region is similar to that in Sub-synchronization region although the former is a slightly better one as compared with the latter, as shown in Fig. 4(d).

As for the investigation of the drift parameters Δa and Δb in the unidirectionally coupled system, it has been found that the results obtained are similar to those in mutual coupling systems. However, the blow-up phenomenon was not observed here. The overall results are summarized and tabulated in Table IV.

V. CONCLUDING REMARKS

This paper reports the investigation of the robustness in synchronization for two coupled Chua's circuits by perturbing their parameters. This study was carried out using both mutually and unidirectionally coupling techniques. From the results obtained by numerical computation, we can observe and draw up the fol-

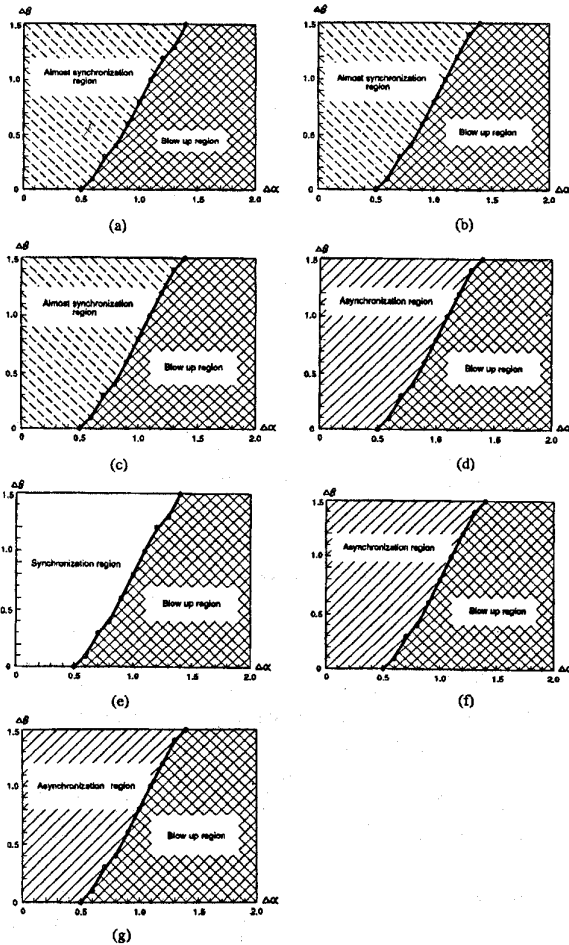

Fig. 7. Performance of synchronization against the drifts of α and β in two unidirectionally coupled Chua's circuits. Blank region is in synchronization mode, backslash-dashed regions are in almost synchronization mode, slashed regions are in asynchronization mode, and mesh regions are in blow-up. Vertical axis: $\Delta\beta$, Horizontal axis: $\Delta\alpha$. Parameter values are listed in Table III.

lowing concluding remarks:

(1) a coupled system, in which the state variable x is the only one for coupling, has been found to be the most robust case against any drift in parameters. Furthermore, the synchronization is independent of the drifts in a and b ;

(2) to synchronize the system without the use of x for coupling, the coupled system is extremely sensitive to the drifts in a and b ;

(3) both mutually and unidirectionally coupled systems achieve similar results in synchronization against the parametric mismatch, although in some cases, the unidirectional coupling approach is more favorable;

(4) the use of state variable z for coupling has the worst performance for synchronization, and it should not be recommended; and

(5) due to the space limitation of this paper, it should also be noted that only the positive increase of percentage for the parameter drifts were considered. In fact, the similar phenomena have also been observed should the process be reversed.

TABLE IV
PERFORMANCE AGAINST DRIFTS OF a AND b IN
MASTER-SLAVE SYSTEM

Case	Mode	figure
5	Synchronization	5(b)
1,2,3	Sub-synchronization	5(a)
4,6,7	Asynchronization	5(c)

VI. REFERENCES

- [1] L. M. Pecora and T. L. Carroll, "Synchronization in chaotic systems," *Phys. Rev. Lett.*, vol. 64, 1990, pp. 821-824.
- [2] V. S. Afraimovich, N. N. Verichev, and M. I. Rabinovich, "Stochastic synchronization of oscillations in dissipative systems," *Izv. VUZ. Radiofiz. RPQAE.*, vol. 29, 1986, pp. 795-803.
- [3] L. O. Chua, M. Itoh, Lj. Kocarev, and K. Eckert, "Chaos synchronization in Chua's circuit," *J. Circuits, Systems, and Computers*, vol. 3, no. 1, 1993, pp. 93-108.
- [4] T. Kapitaniak, L. O. Chua, and G. Q. Zhong, "Experimental synchronization of chaos using continuous control," *Int. J. Bifurcation and Chaos*, vol. 4, no. 2, 1994, pp. 483-488.
- [5] T. S. Parker and L. O. Chua, *Practical Numerical Algorithms for Chaotic Systems*, Springer-Verlag, 1989.
- [6] T. Matsumoto, "A chaotic attractor from Chua's circuit," *IEEE Trans. Circuits Syst.*, vol. CAS-31, no. 12, 1984, pp. 1055-1058.
- [7] G. Q. Zhong and F. Ayrom, "Experimental confirmation of chaos from Chua's circuit," *Int. J. Circuit Theory Applications*, vol. 13, no. 1, 1985, pp. 93-98.
- [8] L. O. Chua, "The genesis of Chua's circuit," *Int. J. Electron. Commun.*, vol. 46, no. 4, 1992, pp. 250-257.
- [9] R. Madan, ed., *Special Issue on Chua's Circuit: A Paradigm for Chaos, Part 1: Introduction and Applications*, *J. Circuit Syst. Comput.* 3(1993), pp. iii-vii.
- [10] M. P. Kennedy, "Robust op amp realization of Chua's circuit," *Frequenz*, vol. 46, 1992, pp. 66-80.
- [11] G. Q. Zhong, K. T. Ko, and K. F. Man, "Synchronization boundaries in coupled Chua's circuits", in *Proceedings of the China Fourteenth Conference on Circuits and Systems (NCCAS'98)*, Fuzhou, China, April 7-10, 1998, pp. 398-401.