

Global Unfolding of Chua's Circuit

Leon O. CHUA[†], Nonmember

SUMMARY By adding a linear resistor in series with the inductor in Chua's circuit, we obtain a circuit whose state equation is *topologically conjugate* (i.e., equivalent) to a 21-parameter family \mathcal{C} of continuous odd-symmetric piecewise-linear equations in \mathcal{R}^3 . In particular, except for a subset of measure zero, every system or vector field belonging to the family \mathcal{C} , can be *mapped* via an explicit non-singular linear transformation into this circuit, which is uniquely determined by 7 parameters. Since no circuit with less than 7 parameters has this property, this augmented circuit is called an *unfolding* of Chua's circuit — it is analogous to that of “unfolding a vector field” in a small neighborhood of a singular point. Our unfolding, however, is *global* since it applies to the entire state space \mathcal{R}^3 . The significance of the *unfolded Chua's Circuit* is that the *qualitative dynamics* of every autonomous 3rd-order chaotic circuit, system, and differential equation, containing one odd-symmetric 3-segment piecewise-linear function can be mapped into this circuit, thereby making their separate analysis unnecessary. This immense power of unification reduces the investigation of the many heretofore unrelated publications on chaotic circuits and systems to the analysis of only one *canonical* circuit. This unified approach is illustrated by many examples selected from a zoo of more than 30 strange attractors extracted from the literature. In addition, a gallery of 18 strange attractors in full color is included to demonstrate the immensely rich and complex dynamics of this simplest among all chaotic circuits.

key words: Chua's circuit, Chua's oscillator, chaos, bifurcation, nonlinear circuits, nonlinear dynamics

1. Introduction

1.1 Historical Background

The circuit shown in Fig. 1 (a) was synthesized to be the *simplest* autonomous (i.e., no input signals) electronic circuit generator of *chaotic* signals. The history on the conception of this circuit and its systematic synthesis procedure are summarized in Ref.(1), which is based in part on the author's opening lecture given at the *Workshop on Nonlinear Theory and its Applications* (NOLTA '92), held at Waseda University, Tokyo, in January 1992. The chaotic nature of this circuit was first verified by *computer simulation** by Matsumoto, who named it *Chua's circuit*,⁽²⁾ and confirmed *experimentally* by Zhong and Ayrom.⁽³⁾ The author was not involved in these two publications

because shortly after he had designed the circuit of Fig. 1, he was rushed to a hospital in Tokyo for major surgery, an illness that took him almost a year to recuperate.

A comprehensive mathematical analysis of Chua's circuit and the first rigorous proof of its chaotic property are given in Ref.(4). Because Chua's circuit was,

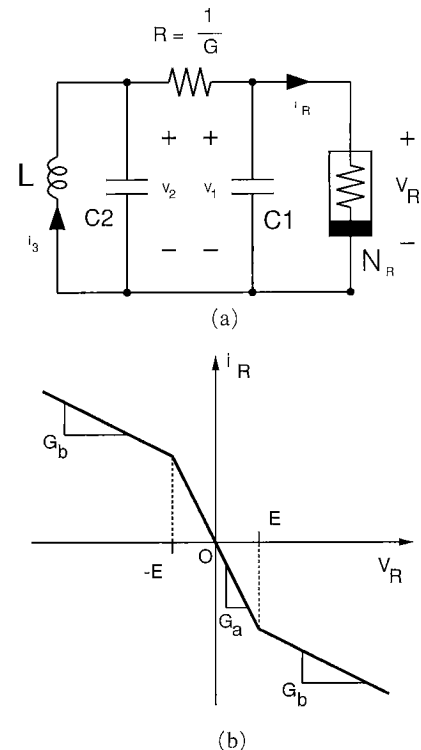

Fig. 1 (a) Chua's circuit.

(b) v - i characteristic of the nonlinear resistor (drawn with $G_a < G_b \leq 0$).

* The episode leading to this event was vividly described in Ref.(1). Matsumoto's role at that point in time was that of a programmer, implementing the instructions from the author. However, Matsumoto's strong leadership in relentlessly driving his entire team of students to crank out, by brute-force computer calculations, the cross section of the strange attractor had led to the prompt identification of its *double-spiral* structure. The subsequent eigenvalue and eigenspace calculations were made by Matsumoto, following the detailed procedures furnished by Komuro.

Manuscript received January, 13, 1993.

Manuscript revised February 4, 1993.

[†] The author is with the Department of Electrical Engineering and Computer Sciences, University of California, Berkeley, CA 94720, USA.

and still is, the only known physical system whose mathematical model is capable of duplicating all experimentally observed chaotic and bifurcation phenomena, and which has yielded to a rigorous mathematical proof, it has generated worldwide interests not only among electrical engineers, but also mathematicians and physicists, as evidenced by the extensive literature on this circuit (see the Chronological Bibliography in Sect. 7). These publications, which covers extensively the experimental, numerical, and mathematical aspects of this circuit, has made Chua's circuit the best understood—in terms of its nonlinear dynamics—among all known chaotic systems, and has triggered an avalanche of recent research activities on the applications of chaos, as documented in a recent Special Session of the Midwest Symposium on Circuits and Systems devoted to “Chua's Circuits,”⁽⁵⁾ and in two Special Issues of the *Journal of Circuits, Systems, and Computers*, entitled, “Chua's circuit: A Paradigm for chaos,” and edited by R. N. Madan.^{(6),(7)}

1.2 Recent Applications

In spite of their extreme sensitivities to initial conditions, two identical Chua's circuits and/or their subcircuits, can be operated in phase *synchronization*, even when operating in a chaotic regime.^{(8),(9)} In addition, several methods have been developed for *controlling* chaos in Chua's circuit.^{(10)–(15)} The possibility for synchronizing and controlling chaos has already been exploited in the design of secure communication systems.^{(16),(17)} Moreover, a new phenomenon called “Stochastic Resonance” has recently been discovered in Chua's circuit,^{(18),(19)} which can be applied to design novel amplifiers whose output SNR (signal-to-noise ratio) is considerably *greater* than the input SNR, an impressive feat that can not be achieved by any *linear* amplifier whose output SNR is always less than that of the input because the internal amplifier noise will *degrade* the SNR further.

Although the nonlinear resistor in the circuit of Fig. 1(a) can be easily built using only a dual op-amp package and 6 linear resistors,^{(20),(21)} an integrated circuit version of this nonlinear device, powered by a single 9-V battery, has been built.⁽²²⁾ Therefore, even the nonlinear resistor in Fig. 1(a) can be mass produced as off-the-shelf components for future large scale industrial applications.

1.3 Recent Generalizations

Chua's circuit has recently been generalized in many directions. One direction simply substitutes the *piecewise-linear* function of the nonlinear resistor by a smooth function, such as a polynomial.⁽²³⁾ Another direction models Chua's circuit by various 1-D maps.^{(24),(25)} A third direction investigates a CNN

(Cellular Neural Network) array of Chua's circuits.^{(26),(27)} Still another direction increases the dimension of the state space but retaining the single scalar nonlinearity. For example, Ref. (28) uses a finite number of discrete lossy transmission line sections as the resonator, Ref. (29) uses a terminated coaxial cable as the resonator, and Ref. (30) uses a delay line as the resonator. Yet another direction of generalization focuses on an in-depth mathematical characterization of the geometrical structure of the strange attractors.^{(31),(32)} All of these generalizations are fascinating and could give rise to many novel applications. For example, Ref. (33) uses a cubic nonlinearity and the normal form theory for low-level visual sensing, and Ref. (34) makes use of a delay-line resonator to synthesize novel tones and music.

2. Strange Attractors from Chua's Circuit

2.1 Concept of Equivalence of Dynamic Nonlinear Circuits

Table 1 shows 6 *non-periodic* attractors so far found from Chua's circuit of Fig. 1.[†] There are several other 3rd-order circuits^{(35)–(40)} and systems^{(41)–(43)} which are also known to have strange attractors. All of these circuits and systems are described by a continuous, odd-symmetric (with respect to some point of symmetry) piecewise-linear vector field in \mathcal{R}^3 . While all of these attractors appear to be different from each other, it is natural to ask whether a homeomorphic image of some, if not all, of these attractors might also be found in Chua's circuit with an appropriate choice of the 6 circuit parameters $\{C_1, C_2, L, R, G_a, G_b\}$. In particular, if such a homeomorphism holds globally in the entire state space for all trajectories, the two systems are identical from a dynamical point of view, and the two circuits are therefore said to be *equivalent*. To answer this question, let (μ_1, μ_2, μ_3) denote the eigenvalues associated with the linear vector field in the region D_0 corresponding to the inner segment through the origin (with slope $G_j = G_a$) in Fig. 1(b). Let (ν_1, ν_2, ν_3) denote the eigenvalues associated with the affine vector field in the regions D_1 and D_{-1} corresponding to the outer segments (with identical slope $G_j = G_b$) in Fig. 1(b). Let (μ'_1, μ'_2, μ'_3) , and (ν'_1, ν'_2, ν'_3) be the eigenvalues of the corresponding linear and affine vector fields, respectively, of any circuit candidate from Ref. (35)–(40), or system candidate from Ref. (41)–(43). It follows from Theorem 3.1 (p. 1078) of Ref. (4) that this candidate is *equivalent*, or *topologically conjugate* to be precise,⁽⁴⁴⁾ to Chua's circuit if, and only if, $\mu'_j = \mu_j$, and $\nu'_j = \nu_j$, $j = 1, 2, 3$. Hence, the following algorithm can be used to find the parameters so that Chua's

[†] In Table 1–5, we have scaled the circuit parameters to a reasonable range for readers who wish to observe the attractors in a real circuit implementation.

Table 1 Attractors from Chua's circuit. In the 3-D phase portraits, the units on the V_1 and V_2 axes are volts, and the units on the I_3 axis is milliamps. $E=1$ V.

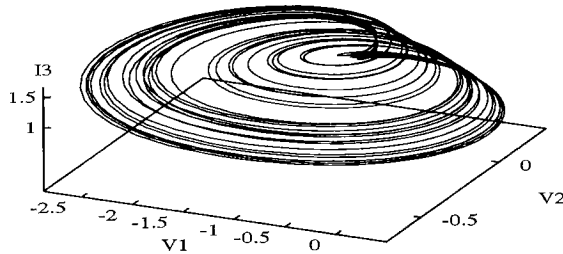
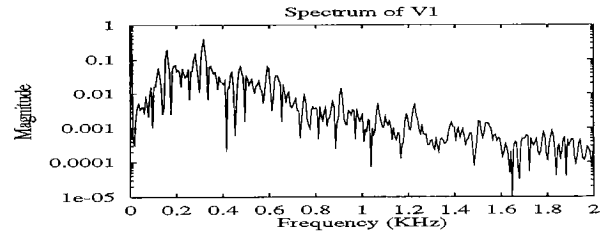
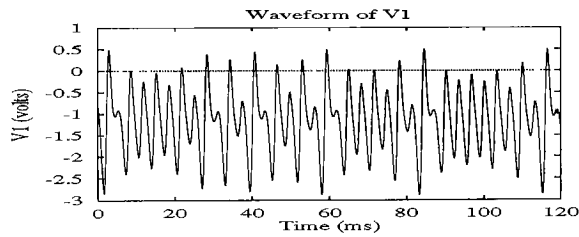

1.1 $C_1 = -149nF$, $C_2 = 1\mu F$, $L = -658mH$, $G_a = -1.14mS$, $G_b = -0.714mS$, $R = 1K\Omega$.

Eigenvalues: $\mu_1 = 16.4$, $\mu_2 = -1.08 \times 10^3 + 2.33 \times 10^3 j$, $\mu_3 = -1.08 \times 10^3 - 2.33 \times 10^3 j$, $\nu_1 = -672$, $\nu_2 = 796 + 1.93 \times 10^3 j$, $\nu_3 = 796 - 1.93 \times 10^3 j$.

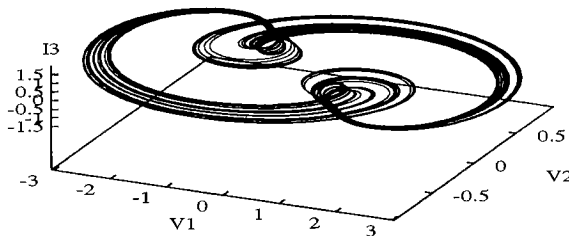
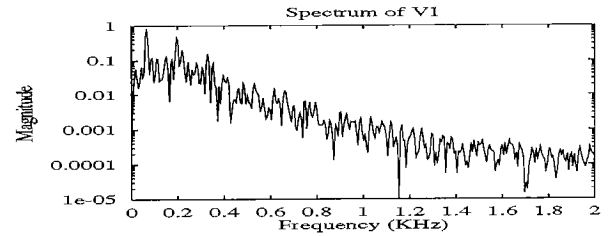
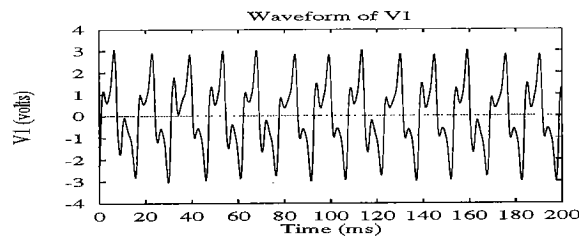

1.2 $C_1 = -245nF$, $C_2 = 1\mu F$, $L = -500mH$, $G_a = -1.14292mS$, $G_b = -0.7142mS$, $R = 1K\Omega$.

Eigenvalues: $\mu_1 = 599$, $\mu_2 = -1.67 \times 10^3 + 1.74 \times 10^3 j$, $\mu_3 = -1.67 \times 10^3 - 1.74 \times 10^3 j$, $\nu_1 = -1.06 \times 10^3$, $\nu_2 = 612 + 1.35 \times 10^3 j$, $\nu_3 = 612 - 1.35 \times 10^3 j$.

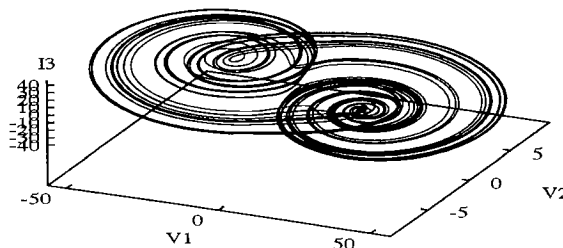
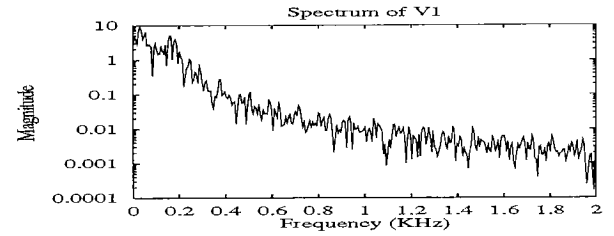
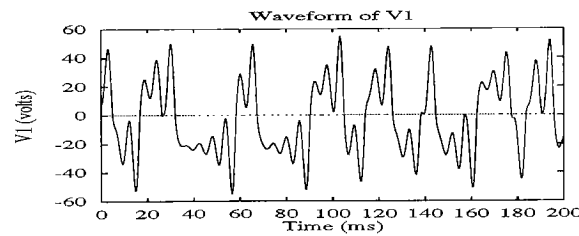

1.3 $C_1 = -203nF$, $C_2 = 1\mu F$, $L = -274mH$, $G_a = -2.497mS$, $G_b = -0.9301mS$, $R = 1K\Omega$.

Eigenvalues: $\mu_1 = -6.34 \times 10^3$, $\mu_2 = -3.31 \times 10^3$, $\mu_3 = 1.28 \times 10^3$, $\nu_1 = -992$, $\nu_2 = 168 + 1.11 \times 10^3 j$, $\nu_3 = 168 - 1.11 \times 10^3 j$.

Table 1 (Continued.)

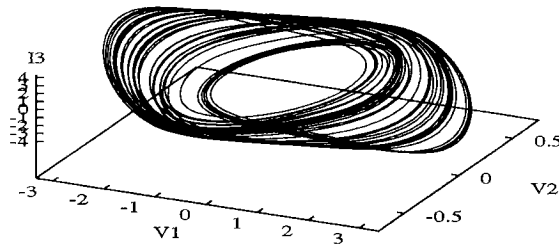
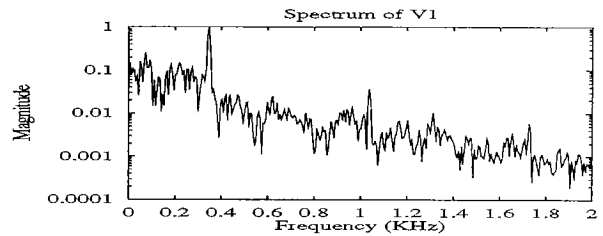
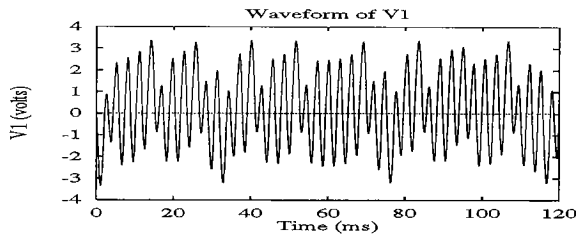

1.4 $C_1 = 120nF$, $C_2 = 1\mu F$, $L = 83.9mH$, $G_a = -0.7048mS$, $G_b = -1.146mS$, $R = 1K\Omega$.
Eigenvalues: $\mu_1 = -3.86 \times 10^3$, $\mu_2 = 200 + 2.75 \times 10^3j$, $\mu_3 = 200 - 2.75 \times 10^3j$, $\nu_1 = 2.18 \times 10^3$, $\nu_2 = -982 + 2.39 \times 10^3j$, $\nu_3 = -982 - 2.39 \times 10^3j$.

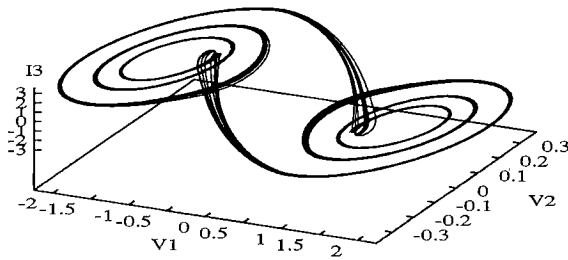
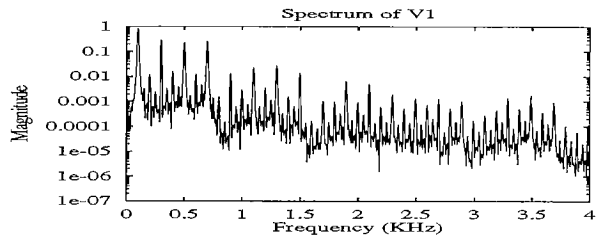
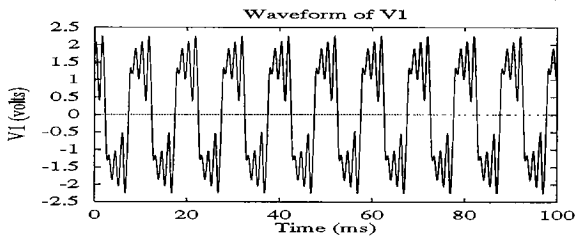

1.5 $C_1 = 64.1nF$, $C_2 = 1\mu F$, $L = 35mH$, $G_a = -1.143mS$, $G_b = -0.7143mS$, $R = 1K\Omega$. Initial Conditions: $v_1 = 1.8035v$, $v_2 = 0.1804v$, $i_3 = -1.8797mA$.
Eigenvalues: $\mu_1 = 7.95 \times 10^3$, $\mu_2 = -1.12 \times 10^3 + 4.48 \times 10^3j$, $\mu_3 = -1.12 \times 10^3 - 4.48 \times 10^3j$, $\nu_1 = -6.05 \times 10^3$, $\nu_2 = 298 + 4.58 \times 10^3j$, $\nu_3 = 298 - 4.58 \times 10^3j$.

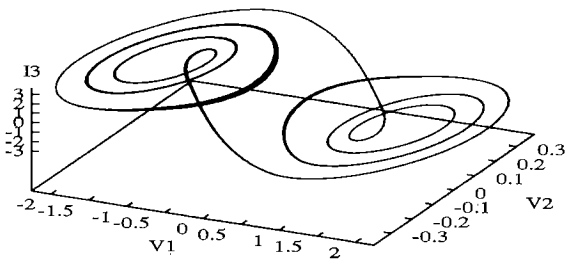
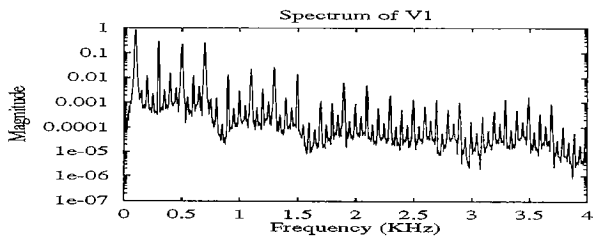
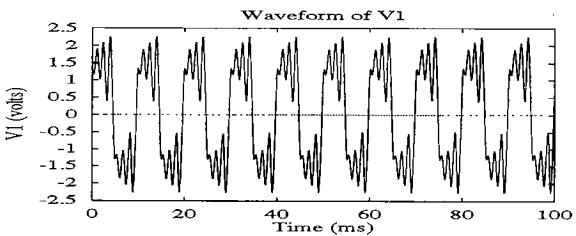

1.6 $C_1 = 64.1nF$, $C_2 = 1\mu F$, $L = 35mH$, $G_a = -1.143mS$, $G_b = -0.7143mS$, $R = 1K\Omega$. Initial Conditions: $v_1 = 1.1638v$, $v_2 = -0.09723$, $i_3 = -0.90565mA$.
Eigenvalues: $\mu_1 = 7.95 \times 10^3$, $\mu_2 = -1.12 \times 10^3 + 4.48 \times 10^3j$, $\mu_3 = -1.12 \times 10^3 - 4.48 \times 10^3j$, $\nu_1 = -6.05 \times 10^3$, $\nu_2 = 298 + 4.58 \times 10^3j$, $\nu_3 = 298 - 4.58 \times 10^3j$.

circuit has an attractor which is homeomorphic to that of a given circuit or system candidate:[†]

Equivalent Chua's Circuit Algorithm

1. Calculate the eigenvalues (μ'_1, μ'_2, μ'_3) , and (ν'_1, ν'_2, ν'_3) associated with the linear and affine vector fields, respectively, of the circuit or system candidate whose attractor is being mapped into Chua's circuit, up to a homeomorphism (i.e., linear conjugacy).
2. Find a set of circuit parameters $\{C_1, C_2, L, R, G_a, G_b\}$ so that the resulting eigenvalues μ_j, ν_j for Chua's circuit satisfy $\mu_j = \mu'_j$ and $\nu_j = \nu'_j, j=1, 2, 3$.

2.2 Eigenvalue Constraints in Chua's Circuit

Unfortunately, in general, the circuit parameters in step 2 of the preceding algorithm do *not* exist for an arbitrarily given set of eigenvalues $\{\mu'_1, \mu'_2, \mu'_3; \nu'_1, \nu'_2, \nu'_3\}$. To uncover the reason, consider the following characteristic polynomial associated with the Jacobian matrix in regions D_0 , and D_1, D_{-1} , respectively:

$$(s - \mu_1)(s - \mu_2)(s - \mu_3) = s^3 - p_1 s^2 + p_2 s - p_3 \quad (1)$$

$$(s - \nu_1)(s - \nu_2)(s - \nu_3) = s^3 - q_1 s^2 + q_2 s - q_3 \quad (2)$$

where

$$\left. \begin{aligned} p_1 &= \mu_1 + \mu_2 + \mu_3 & q_1 &= \nu_1 + \nu_2 + \nu_3 \\ p_2 &= \mu_1 \mu_2 + \mu_2 \mu_3 + \mu_3 \mu_1 & q_2 &= \nu_1 \nu_2 + \nu_2 \nu_3 + \nu_3 \nu_1 \\ p_3 &= \mu_1 \mu_2 \mu_3 & q_3 &= \nu_1 \nu_2 \nu_3 \end{aligned} \right\} \quad (3)$$

Since the set $\{p_1, p_2, p_3; q_1, q_2, q_3\}$ is *uniquely* determined by the eigenvalues $\{\mu_1, \mu_2, \mu_3; \nu_1, \nu_2, \nu_3\}$ via Eq. (3), we will henceforth refer to it as the "equivalent eigenvalue parameters." These parameters are more convenient to work with in practice not only because they are just the coefficients of the characteristic polynomials (1) and (2), thereby simplifying the subsequent algebra in deriving the circuit parameters, but also because they are *real* numbers, whereas the associated eigenvalues may be complex numbers. Now it is shown in Ref. (44) that there exists a set of circuit parameters $\{C_1, C_2, L, R, G_a, G_b\}$ in step 2 of the Equivalent Chua's Circuit Algorithm *only if* the equivalent eigenvalue parameters satisfy the constraint (see Eq. (21) of Ref. (44)):

$$\begin{aligned} h(p_1, p_2, p_3, q_1, q_2, q_3) &\triangleq (p_2 - q_2)(p_3 - q_3) \\ &\quad - (p_1 - q_1)(p_3 q_1 - q_3 p_1) = 0 \quad (4) \end{aligned}$$

Equation (4) defines a 5-dimensional surface in \mathcal{R}^6 . Only those circuit candidates from Ref. (35)–(40), or system candidates from Ref. (41)–(43), whose equivalent eigenvalue parameters fall on this surface can have an equivalent Chua's circuit. It follows from this analysis that the class of circuits and systems which are equivalent to Chua's circuit is relatively small. This

result has led to a search for the *simplest* circuit which is equivalent to all circuits and systems from Ref. (35)–(43), as well as Chua's circuit and others. The first circuit found with this property, except for a set of measure zero, is given in Ref. (44). Such a circuit is said to be *canonical* because it contains only 7 circuit parameters, which can be shown to be the *minimum* number needed for any circuit satisfying step 2 of the "Equivalent Chua's Circuit Algorithm".

3. Unfolding Chua's Circuit

Although the circuit in Ref. (44), as well as several other circuits having 7 parameters, which have since been found to be also canonical in the above sense, they are not obtained by augmenting a new circuit element to the circuit of Fig. 1 and hence can not be reduced to Chua's circuit by replacing one of the elements by an open or a short circuit. Our main result of this paper is to prove that the circuit shown in Fig. 2, obtained by inserting a *linear* resistor R_0 in series with the inductor in Chua's circuit, is also canonical. The state equation for this augmented circuit is given by

$$\begin{aligned} \frac{dv_1}{dt} &= \frac{1}{C_1} [G(v_2 - v_1) - f(v_1)] \\ \frac{dv_2}{dt} &= \frac{1}{C_2} [G(v_1 - v_2) + i_3] \\ \frac{di_3}{dt} &= -\frac{1}{L} (v_2 + R_0 i_3) \end{aligned} \quad (5)$$

where

$$G = \frac{1}{R}$$

and

$$f(v_1) = G_b v_1 + \frac{1}{2} (G_a - G_b) \{|v_1 + E| - |v_1 - E|\} \quad (6)$$

denotes an odd-symmetric v - i characteristic, such as those shown in Fig. 2(b) of the nonlinear resistor with a slope equal to G_a in the inner region, and G_b in the outer regions. The voltage E is the breakpoint voltage which can be assumed to be equal to unity without any loss of generality in so far as the qualitative dynamics is concerned. On the other hand, the two slopes G_a and G_b may assume *any sign and value*.

Equation (5) is called a *global unfolding* of Chua's circuit because of its analogy to the mathemati-

[†] The proof of Theorem 3.1 in Ref. (4) is given for the case where the circuit has a pair of complex-conjugate eigenvalues in the linear and affine regions. It can be easily shown that the theorem holds also when all 3 eigenvalues are real numbers.

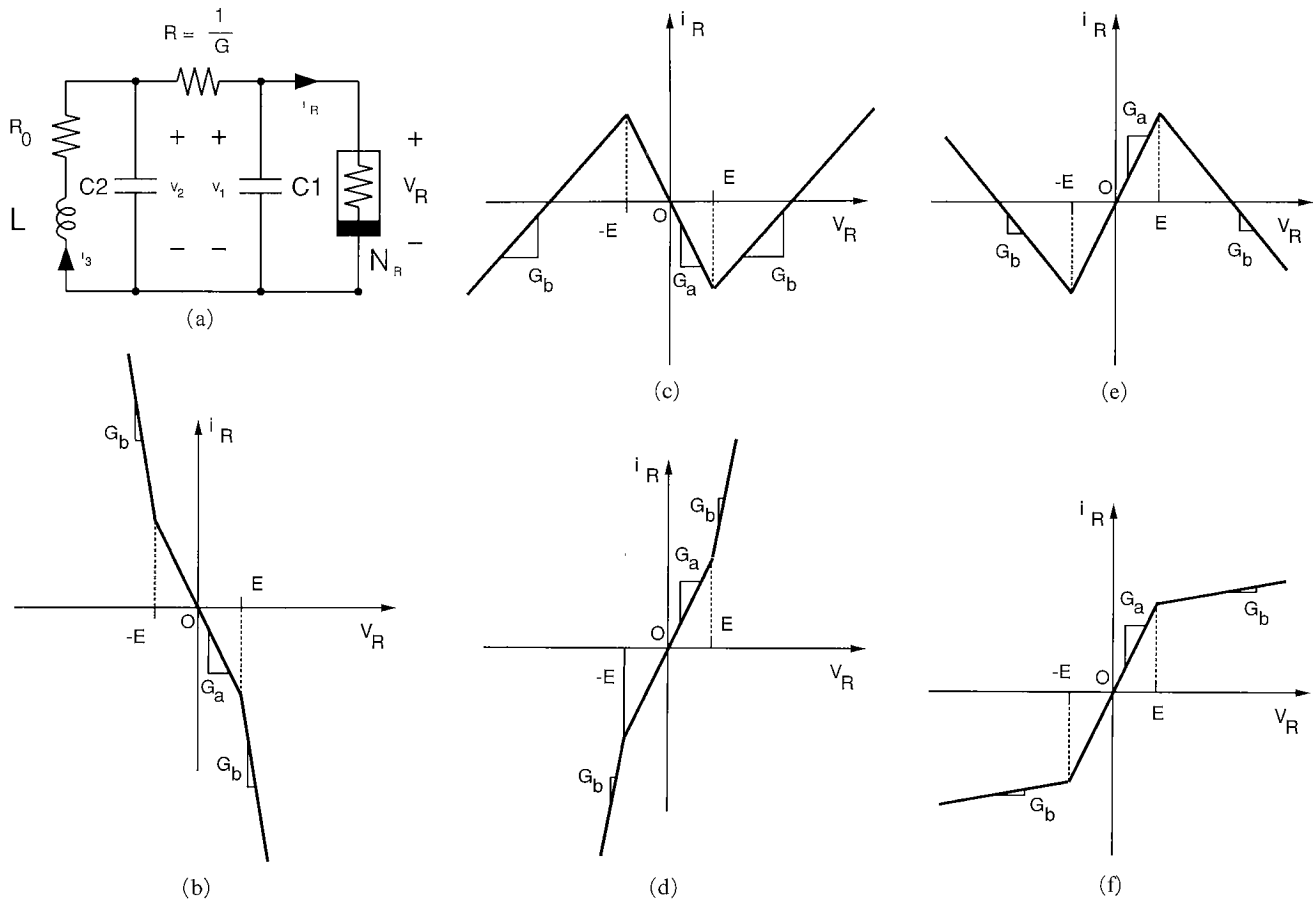

Fig. 2 (a) Unfolded canonical circuit. The nonlinear resistor may be characterized by any piecewise continuous function. For the family \mathcal{C} of vector fields studied in this paper, this is assumed to be piecewise-linear, such as shown in Fig.1 (b), where $G_a < G_b \leq 0$, or

- (b) $G_b < G_a < 0$,
- (c) $G_a < 0, G_b > 0$,
- (d) $G_b > G_a > 0$,
- (e) $G_a > 0, G_b < 0$, and
- (f) $G_a > G_b > 0$.

cal theory of the “unfolding of a singularity” of a vector field,⁽⁴⁵⁾ where a minimum number of parameters is added in order to observe the dynamics near the singular point in its *full generality*. However, in contrast to the normal form theory of unfolding, which is a *local theory* applicable only to a small neighborhood of a singular point, our unfolded Eq.(5) is defined over the entire state space \mathcal{R}^3 , and hence it is called a *global unfolding*. Indeed, we will prove in Sect. 4 that the unfolded Chua’s circuit in Fig. 2 is *canonical* in the sense that it is imbued with *every possible qualitative dynamics* of an extremely large family \mathcal{C} of piecewise-linear differential equations in \mathcal{R}^3 to be defined precisely in Sect. 4. But, first, we will show that the unfolded Chua’s circuit in Fig. 2 contains enough circuit parameters for it to realize any

prescribed set of eigenvalues $\{\mu_1, \mu_2, \mu_3, \nu_1, \nu_2, \nu_3\}$, except for a set of measure zero. Let us calculate the Jacobian matrix M_a in region D_0 and M_b in region D_1 and D_{-1} , respectively:

$$M_j = \begin{bmatrix} -\frac{G + G_j}{C_1} & \frac{G}{C_1} & 0 \\ \frac{G}{C_2} & -\frac{G}{C_2} & \frac{1}{C_2} \\ 0 & -\frac{1}{L} & -\frac{R_0}{L} \end{bmatrix} \quad (7)$$

where $j = a$ in region D_0 , and $j = b$ in regions D_1 and D_{-1} . The characteristic polynomial of M_j is given by:

$$\begin{aligned} \det(s\mathbf{1}-\mathbf{M}_j) &= s^3 + \left[\frac{G+G_j}{C_1} + \frac{G}{C_2} + \frac{R_0}{L} \right] s^2 \\ &+ \left[\frac{GG_j}{C_1 C_2} + \frac{G+G_j}{C_1 L} R_0 \right. \\ &+ \left. \frac{GR_0}{C_2 L} + \frac{1}{C_2 L} \right] s \\ &+ \frac{R_0 G G_j + G + G_j}{C_1 C_2 L} \end{aligned} \quad (8)$$

Identifying the coefficients of s^2 , s^1 , and s^0 in Eqs. (1) and (2) with Eq. (8) where $j = a$ in D_0 , and $j = b$ in D_1 and D_{-1} , we obtain:

$$\frac{G+G_a}{C_1} + \frac{G}{C_2} + \frac{R_0}{L} = -p_1 \quad (9)$$

$$\frac{GG_a}{C_1 C_2} + \frac{G+G_a}{C_1 L} R_0 + \frac{GR_0}{C_2 L} + \frac{1}{C_2 L} = p_2 \quad (10)$$

$$\frac{R_0 G G_a + G + G_a}{C_1 C_2 L} = -p_3 \quad (11)$$

which hold in the inner region D_0 , and

$$\frac{G+G_b}{C_1} + \frac{G}{C_2} + \frac{R_0}{L} = -q_1 \quad (12)$$

$$\frac{GG_b}{C_1 C_2} + \frac{G+G_b}{C_1 L} R_0 + \frac{GR_0}{C_2 L} + \frac{1}{C_2 L} = q_2 \quad (13)$$

$$\frac{R_0 G G_b + G + G_b}{C_1 C_2 L} = -q_3 \quad (14)$$

which hold in the outer regions D_1 and D_{-1} .

Equations (9)-(14) constitute a system of 6 independent equations involving 7 *unknown* circuit parameters $\{C_1, C_2, L, R, R_0, G_a, G_b\}$ and 6 *known* (prescribed) equivalent eigenvalue parameters $\{p_1, p_2, p_3, q_1, q_2, q_3\}$. Hence, we can assign a convenient value to one of the circuit parameters and solve for the rest. After some involved algebra, we obtain the following *explicit* formulas:

$$\begin{aligned} C_1 &= 1 \\ C_2 &= -\frac{k_2}{k_3^2} \\ L &= -\frac{k_3^2}{k_4} \\ R &= -\frac{k_3}{k_2} \\ R_0 &= -\frac{k_1 k_3^2}{k_2 k_4} \\ G_a &= -p_1 - \left(\frac{p_2 - q_2}{p_1 - q_1} \right) + \frac{k_2}{k_3} \\ G_b &= -q_1 - \left(\frac{p_2 - q_2}{p_1 - q_1} \right) + \frac{k_2}{k_3} \end{aligned} \quad (15)$$

where $\{p_1, p_2, p_3, q_1, q_2, q_3\}$ are the "equivalent eigen-

value parameters" defined in Eq. (3), and

$$\begin{aligned} k_1 &\triangleq -p_3 + \left(\frac{q_3 - p_3}{q_1 - p_1} \right) \left(p_1 + \frac{p_2 - q_2}{q_1 - p_1} \right) \\ k_2 &\triangleq p_2 - \left(\frac{q_3 - p_3}{q_1 - p_1} \right) + \left(\frac{p_2 - q_2}{q_1 - p_1} \right) \left(\frac{p_2 - q_2}{q_1 - p_1} + p_1 \right) \\ k_3 &\triangleq \left(\frac{p_2 - q_2}{q_1 - p_1} \right) - \frac{k_1}{k_2} \\ k_4 &\triangleq -k_1 k_3 + k_2 \left(\frac{p_3 - q_3}{p_1 - q_1} \right) \end{aligned} \quad (16)$$

It follows from the explicit formulas in Eqs. (15), (16) that the "unfolded" Chua's circuit in Fig. 2 can realize any eigenvalues parameters $\{p_1, p_2, p_3, q_1, q_2, q_3\}$, except for a set of *measure zero* $\mathcal{E}_0 \subset \mathcal{R}^6$ where some denominators in Eqs. (15), (16) vanish. In particular, any set of eigenvalue parameters satisfying the following constraints has an associated vector field belonging to \mathcal{E}_0 :

$$\begin{aligned} p_1 - q_1 &= 0 \\ p_2 - \left(\frac{q_3 - p_3}{q_1 - p_1} \right) + \left(\frac{p_2 - q_2}{q_1 - p_1} \right) \left(\frac{p_2 - q_2}{q_1 - p_1} + p_1 \right) &= 0 \\ \left(\frac{p_2 - q_2}{q_1 - p_1} \right) - \frac{k_1}{k_2} &= 0 \\ -k_1 k_3 + k_2 \left(\frac{p_3 - q_3}{p_1 - q_1} \right) &= 0 \end{aligned} \quad (17)$$

Observe from Eqs. (15) and (16) that $R_0 = 0$ when $k_1 = 0$, which is exactly Eq. (4). In other words, when the prescribed eigenvalue parameters belong to the original Chua's circuit in Fig. 1, the calculated value of R_0 will be zero, as it should.

Since the set of eigenvalue parameters $\mathcal{E}_0 \subset \mathcal{R}^6$ which can not be realized by the unfolded Chua's circuit in Fig. 2 has *measure zero*, we can make an arbitrarily small perturbation of any unrealizable eigenvalues belonging to this set to obtain an unfolded Chua's circuit having the "perturbed" eigenvalues

$$\begin{aligned} \{ \mu_1 + \delta\mu_1, \mu_2 + \delta\mu_2, \mu_3 + \delta\mu_3, \\ \nu_1 + \delta\nu_1, \nu_2 + \delta\nu_2, \nu_3 + \delta\nu_3 \} \end{aligned} \quad (18)$$

Since the solution of any system of ordinary differential equations⁽⁴⁶⁾

$$\dot{\mathbf{x}} = \mathbf{f}(\mathbf{x}; \mathbf{p}), \quad \mathbf{f}(\cdot) \in C^1 \quad (19)$$

is a *continuous* function of its parameter vector \mathbf{p} , it follows that for *every* circuit or system belonging to the family \mathcal{C} , defined in Sect. 4, we can find an unfolded Chua's circuit which has exactly the same dynamic behaviors.

4. Topological Conjugacy

The vector field defined by Eq. (5) is but a special case of a much larger family of vector fields which we

define next.

Definition: Family \mathcal{C}

A circuit, system, or vector field defined by a state equation

$$\dot{\mathbf{x}} = \mathbf{f}(\mathbf{x}), \quad \mathbf{x} \in \mathcal{R}^3 \tag{20}$$

is said to belong to **Family** \mathcal{C} iff

- (a) $f(\cdot)$ is continuous
- (b) $f(\cdot)$ is odd-symmetric, i.e.,[†]

$$\mathbf{f}(\mathbf{x}) = -\mathbf{f}(-\mathbf{x})$$

- (c) \mathcal{R}^3 is partitioned by 2 parallel boundary planes U_1 and U_{-1} into an inner region D_0 containing the origin, and two outer regions D_1 and D_{-1} .

Although the boundary planes U_1 and U_{-1} can have any orientation, we will, without loss of generality, assume that a set of coordinate systems has been chosen so that U_1 and U_{-1} are defined as follow ($\mathbf{x} = (x_1, x_2, x_3)^T$):

$$U_1 : x_1 = 1 \tag{21}$$

$$U_{-1} : x_1 = -1 \tag{22}$$

Under this assumption, every member of the family \mathcal{C} can be represented by

$$\dot{\mathbf{x}} = \mathbf{A}\mathbf{x} + \mathbf{b}, \quad x_1 \geq 1 \text{ or } x_1 \leq -1 \tag{23}$$

$$= \mathbf{A}_0\mathbf{x}, \quad -1 \leq x_1 \leq 1 \tag{24}$$

where

$$\mathbf{A} = \begin{bmatrix} a_{11} & a_{12} & a_{13} \\ a_{21} & a_{22} & a_{23} \\ a_{31} & a_{32} & a_{33} \end{bmatrix}, \quad \mathbf{b} = \begin{bmatrix} b_1 \\ b_2 \\ b_3 \end{bmatrix} \tag{25}$$

defines an *affine* vector field in the outer regions D_1 and D_{-1} , and

$$\mathbf{A}_0 = \begin{bmatrix} \alpha_{11} & \alpha_{12} & \alpha_{13} \\ \alpha_{21} & \alpha_{22} & \alpha_{23} \\ \alpha_{31} & \alpha_{32} & \alpha_{33} \end{bmatrix} \tag{26}$$

defines a *linear* vector field in the inner region D_0 .

Equations (23)–(26) define a 21-parameter family of ordinary differential equations. However, since the vector field in the family \mathcal{C} is *continuous*, not all of these 21 parameters can be arbitrarily specified.⁽⁴⁾ In fact, by imposing the continuity constraint, it is easy to show that Eqs.(23)–(24) can be recast into the following equivalent but much more compact explicit form.⁽⁴⁷⁾

$$\dot{\mathbf{x}} = \mathbf{A}\mathbf{x} + \frac{1}{2}\{|\langle \mathbf{w}, \mathbf{x} \rangle + 1| - |\langle \mathbf{w}, \mathbf{x} \rangle - 1|\}\mathbf{b} \triangleq \mathbf{F}(\mathbf{x}) \tag{27}$$

where \mathbf{A} and \mathbf{b} are as defined in Eq.(25), $\mathbf{w} = (1, 0, 0)^T$, and $\langle \cdot, \cdot \rangle$ denotes the vector dot product. Observe that

for $|x_1| \geq 1$, Eq.(27) reduces to Eq.(23). Similarly, when $|x_1| \leq 1$, Eq.(27) reduces to Eq.(24), upon identifying

$$\mathbf{A}_0 = \mathbf{A} + \begin{bmatrix} b_1 & 0 & 0 \\ b_2 & 0 & 0 \\ b_3 & 0 & 0 \end{bmatrix} \tag{28}$$

In other words, the continuity of the vector fields in the family \mathcal{C} implies that the last two columns of the matrices \mathbf{A} and \mathbf{A}_0 must be identical, and that their first columns must differ by the constant vector \mathbf{b} . It follows from Eq.(27) that the family \mathcal{C} of vector fields represents in fact a 12-parameter family of ordinary differential equations *without constraints* among the parameters, or a 21-parameter family where 9 of the 21 parameters $\{a_{ij}, \alpha_{ij}, b_i; i, j = 1, 2, 3\}$ are constrained via Eq.(28).

Since we have given the *explicit* formulas (Eqs. (15), (16)) for calculating the 7 circuit parameters for the unfolded Chua's circuit in Fig.2 to have any prescribed eigenvalues, except for a set of measure zero, we can conclude via Theorem 3.1 from Ref.(4) that every member of the family \mathcal{C} of vector fields outside of the set \mathcal{E}_0 (to be defined shortly) is topologically conjugate to an unfolded Chua's circuit. The proof of Theorem 3.1 in Ref.(4) assumes that both \mathbf{A}_0 and \mathbf{A} have a pair of complex-conjugate eigenvalues because it was intended mainly for the double scroll attractor. A similar proof can be easily given when the eigenvalues of \mathbf{A}_0 and/of \mathbf{A} are all real numbers. We will now restate this fundamental theorem precisely and give a self-contained and simpler proof.

The Global Unfolding Theorem

Let $\{\mu_1, \mu_2, \mu_3, \nu_1, \nu_2, \nu_3\}$ be the eigenvalues associated with a vector field $\mathbf{F}(\mathbf{x}) \in \mathcal{C} \setminus \mathcal{E}_0$, where \mathcal{E}_0 is a set of vector fields whose eigenvalue parameters are constrained by Eq.(17), and by $\det \mathbf{K} = 0$, where \mathbf{K} is defined by the following Eq.(29). Then the unfolded Chua's circuit with parameters defined by Eqs.(15), (16) is *linearly-conjugate*, and hence *equivalent*, to this vector field.

Proof: Without loss of generality, assume that $\mathbf{F}(\mathbf{x})$ is defined by Eq.(27), with \mathbf{A} and \mathbf{b} defined by Eq.(25). Define the non-singular transformation

$$\mathbf{y} = \mathbf{K}\mathbf{x} \tag{29}$$

where

$$\mathbf{K} = \begin{bmatrix} 1 & 0 & 0 \\ a_{11} & a_{12} & a_{13} \\ K_{31} & K_{32} & K_{33} \end{bmatrix} \tag{30}$$

and

[†] We can relax this condition further by allowing the symmetry to be with respect to a point different from the origin, as in the case of Sparrow's system.⁽⁴⁸⁾

$$K_{3i} \triangleq \sum_{j=1}^3 a_{1j} a_{ji}, \quad i=1, 2, 3 \tag{31}$$

Since $F(\mathbf{x}) \in \mathcal{E}_0$,

$$\det \mathbf{K} = a_{12} K_{33} - a_{13} K_{32} \neq 0 \tag{32}$$

Hence, \mathbf{K}^{-1} exists and Eq.(27) transforms into

$$\dot{\mathbf{y}} = (\mathbf{K}\mathbf{A}\mathbf{K}^{-1})\mathbf{y} + \frac{1}{2}\{|\langle (\mathbf{K}^{-1})^T \mathbf{w}, \mathbf{y} \rangle + 1| - |\langle (\mathbf{K}^{-1})^T \mathbf{w}, \mathbf{y} \rangle - 1|\} \mathbf{K}\mathbf{b} \tag{33}$$

where

$$\mathbf{K}\mathbf{A}\mathbf{K}^{-1} = \begin{bmatrix} 0 & 1 & 0 \\ 0 & 0 & 1 \\ p_3 & -p_2 & p_1 \end{bmatrix} \triangleq \tilde{\mathbf{A}} \tag{34}$$

is the *companion* matrix of \mathbf{A} ,

$$(\mathbf{K}^{-1})^T \mathbf{w} = \begin{bmatrix} 1 \\ 0 \\ 0 \end{bmatrix} \triangleq \tilde{\mathbf{w}} = \mathbf{w} \tag{35}$$

$$\mathbf{K}\mathbf{b} = \begin{bmatrix} p_1 - q_1 \\ -p_2 + q_2 + q_1(p_1 - q_1) \\ p_3 - q_3 - q_2(p_1 - q_1) \\ + q_1[-p_2 + q_2 + q_1(p_1 - q_1)] \end{bmatrix} \triangleq \tilde{\mathbf{b}} \tag{36}$$

Hence, the transformed vector field simplifies to

$$\dot{\mathbf{y}} = \tilde{\mathbf{A}}\mathbf{y} + \frac{1}{2}\{|\langle \tilde{\mathbf{w}}, \mathbf{y} \rangle + 1| - |\langle \tilde{\mathbf{w}}, \mathbf{y} \rangle - 1|\} \tilde{\mathbf{b}} \tag{37}$$

henceforth called the *companion vector field*. Observe that both $\tilde{\mathbf{A}}$ and $\tilde{\mathbf{b}}$ are *uniquely* determined by the prescribed eigenvalues $\{\mu_1, \mu_2, \mu_3, \nu_1, \nu_2, \nu_3\}$ via their equivalent eigenvalue parameters

$$\{p_1, p_2, p_3, q_1, q_2, q_3\} \tag{38}$$

We have therefore shown that the given vector field $F(\mathbf{x})$ is topologically conjugate to the companion vector field $\tilde{F}(\mathbf{y})$ defined by Eq.(37).

Now $F(\mathbf{x}) \in \mathcal{C} \setminus \mathcal{E}_0$ implies that there exists an unfolded Chua's circuit defined by the vector field $\tilde{f}(\tilde{\mathbf{x}})$ with $\tilde{\mathbf{x}} = (v_1, v_2, i_3)^T$ via Eq.(5) that has the same prescribed set of eigenvalues as those of $F(\mathbf{x})$. We can recast Eq.(5), with $E=1$, into the canonical piecewise-linear form

$$\begin{aligned} \dot{\tilde{\mathbf{x}}} &= \tilde{\mathbf{A}}\tilde{\mathbf{x}} + \frac{1}{2}\{|\langle \tilde{\mathbf{w}}, \tilde{\mathbf{x}} \rangle + 1| - |\langle \tilde{\mathbf{w}}, \tilde{\mathbf{x}} \rangle - 1|\} \tilde{\mathbf{b}} \\ &\triangleq \tilde{f}(\tilde{\mathbf{x}}) \end{aligned} \tag{39}$$

where

$$\tilde{\mathbf{w}} = (1, 0, 0)^T \tag{40}$$

$$\begin{aligned} \tilde{\mathbf{A}} &= \begin{bmatrix} -\left(\frac{G+G_b}{C_1}\right) & \frac{G}{C_1} & 0 \\ \frac{G}{C_2} & -\frac{G}{C_2} & \frac{1}{C_2} \\ 0 & -\frac{1}{L} & -\frac{R_0}{L} \end{bmatrix}, \\ \tilde{\mathbf{b}} &= \begin{bmatrix} \frac{G_b - G_a}{C_1} \\ 0 \\ 0 \end{bmatrix} \end{aligned} \tag{41}$$

There exists a corresponding non-singular linear transformation

$$\tilde{\mathbf{y}} = \tilde{\mathbf{K}}\tilde{\mathbf{x}} \tag{42}$$

which transforms Eq.(39) into its corresponding companion vector field by Eq.(37), with \mathbf{y} replaced by $\tilde{\mathbf{y}}$, where

$$\tilde{\mathbf{K}} = \begin{bmatrix} 1 & 0 & 0 \\ -\left(\frac{G+G_b}{C_1}\right) & \frac{G}{C_1} & 0 \\ \tilde{K}_{31} & \tilde{K}_{32} & \tilde{K}_{33} \end{bmatrix} \tag{43}$$

and

$$\begin{aligned} \tilde{K}_{31} &= \tilde{a}_{11}\tilde{a}_{11} + \tilde{a}_{12}\tilde{a}_{21} + \tilde{a}_{13}\tilde{a}_{31} \\ &= \left(\frac{G+G_b}{C_1}\right)^2 + \frac{G^2}{C_1 C_2} \end{aligned} \tag{44}$$

$$\begin{aligned} \tilde{K}_{32} &= \tilde{a}_{11}\tilde{a}_{12} + \tilde{a}_{12}\tilde{a}_{22} + \tilde{a}_{13}\tilde{a}_{32} \\ &= -\frac{G(G+G_b)}{C_1^2} - \frac{G^2}{C_1 C_2} \end{aligned} \tag{45}$$

$$\tilde{K}_{33} = \tilde{a}_{11}\tilde{a}_{13} + \tilde{a}_{12}\tilde{a}_{23} + \tilde{a}_{13}\tilde{a}_{33} = \frac{G}{C_1 C_2} \tag{46}$$

But since $\tilde{\mathbf{A}}$ and $\tilde{\mathbf{b}}$ in Eq.(41) are determined *uniquely* by *only* the equivalent eigenvalue parameters $\{p_1, p_2, p_3, q_1, q_2, q_3\}$, it follows that both $F(\mathbf{x})$ and $\tilde{f}(\tilde{\mathbf{x}})$ must transform into one and the *same* companion vector field. Hence, we have $\mathbf{y} = \tilde{\mathbf{y}}$. It follows from Eqs.(29) and (42) that

$$\mathbf{x} = \mathbf{T} \begin{bmatrix} v_1 \\ v_2 \\ i_3 \end{bmatrix} \tag{47}$$

where

$$\mathbf{T} \triangleq \mathbf{K}^{-1}\tilde{\mathbf{K}} \tag{48}$$

transforms every circuit, system, or vector field belonging to the family $\mathcal{C} \setminus \mathcal{E}_0$ into an unfolded Chua's circuit. This completes the proof of our main theorem. \square

Remarks:

1. The unfolded Chua's circuit in the global unfolding theorem is *unique*, modulo a normalization constant C_1 , which was assumed to be unity in the first formula of Eq.(15) for convenience. Using the language from linear circuit theory, this normalization corresponds to setting the "impedance level" of the linearized small-signal equivalent circuit.
2. Any unrealizable vector field belonging to the set \mathcal{E}_0 can be perturbed to a *qualitatively* identical vector field belonging to the family \mathcal{E} , and hence once again realizable by an unfolded Chua's circuit. In practice, to avoid numerical ill conditioning, it is more convenient to perturb the equivalent eigenvalue parameters from $\{p_1, p_2, p_3, q_1, q_2, q_3\}$ into $\{p_1 + \delta p_1, p_2 + \delta p_2, p_3 + \delta p_3, q_1 + \delta q_1, q_2 + \delta q_2, q_3 + \delta q_3\}$, where δp_i and δq_i are chosen to be sufficiently small (at least one must be non-zero).
3. The condition given in Eq.(32) is equivalent to the assumption that there is no plane or line parallel to the boundary planes which is invariant under the action of the linear vector field in the middle region.

5. Applications of the Unfolded Canonical Chua's Circuit

5.1 Mapping Chaotic Circuits from Family \mathcal{E}

We can now easily "map" any chaotic circuit belonging to the family of vector fields $\mathcal{E} \setminus \mathcal{E}_0$ into the unfolded canonical Chua's circuit shown in Fig. 2 by applying Step 1 of the *Equivalent Chua's Circuit Algorithm* from Sect. 2.1 and calculating the circuit parameters $\{C_1, C_2, L, R, R_0, G_a, G_b\}$ using Eqs.(15), (16).

The purpose of this section is to illustrate this procedure by selecting a few chaotic circuits belonging to $\mathcal{E} \setminus \mathcal{E}_0$ and demonstrate the immense advantage of this unifying approach via a single circuit of universal utility.

Example 1: Consider the chaotic circuit given in Fig. 1 of Ref.(38), and its strange attractor in Fig. 3 of Ref.(38) which we reproduce below in Fig. 3(a). Using the circuit parameters provided in Ref.(38), we have calculated the following eigenvalues:

$$\left. \begin{aligned} \mu_1 &= 0.367929, \quad \mu_2 = -0.283965 + j1.1306, \\ \mu_3 &= -0.283965 - j1.1306 \\ \nu_1 &= -10.9656, \quad \nu_2 = 0.132777 + j0.945683, \\ \nu_3 &= 0.132777 - j0.945683 \end{aligned} \right\} \quad (49)$$

The corresponding equivalent eigenvalue parameters calculated from Eq.(3) are given by:

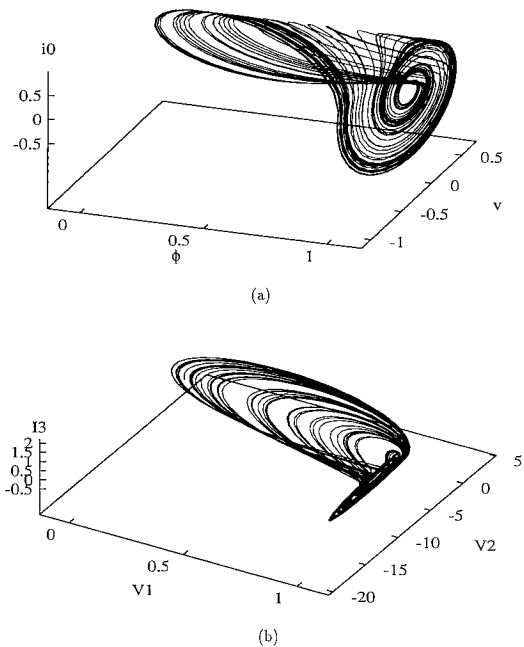

Fig. 3 (a) Strange attractor reproduced from Fig.3 of Ref.(38). (b) Equivalent strange attractor generated by the unfolded Chua's Circuit with parameters given by Eq.(51).

$$\left. \begin{aligned} p_1 &= -0.200001, \quad p_2 = 1.149935, \\ p_3 &= 0.499976 \\ q_1 &= -10.700046, \quad q_2 = -2.00013, \\ q_3 &= -10.000036 \end{aligned} \right\} \quad (50)$$

Substituting the parameters from Eq.(50) into Eqs.(15), (16), we obtain the following parameters for the equivalent "unfolded" canonical Chua's circuit:

$$\left. \begin{aligned} C_1 &= 1, \quad C_2 = -0.0328356, \quad L = -2.761110 \\ R &= -10.11553, \quad G = -0.098857895, \\ R_0 &= 9.205471, \\ G_a &= 0.5988526, \quad G_b = 11.09890 \end{aligned} \right\} \quad (51)$$

The strange attractor associated with Eq.(51) is shown in Fig. 3(b). While the 2 attractors in Fig. 3 are not identical to each other, they are in fact equivalent in view of the *global unfolding theorem* from the preceding section. In fact, they are related by the transformation matrix $T = K^{-1} \bar{K}$ in Eq.(48), where

$$K = \begin{bmatrix} 1 & 0 & 0 \\ -\frac{b}{\epsilon} & 0 & -b \\ \frac{b^2}{\epsilon^2} + \frac{b^2}{\epsilon} & b & \frac{b^2}{\epsilon} - b(a-b) \end{bmatrix}$$

Table 2 Period doubling route to Chaos. The fixed parameters are $R_0=0 \Omega$, $R=1 \text{ k}\Omega$, $L=6.25 \text{ mH}$, $G_a=-1.143 \text{ mS}$, $G_b=-0.714 \text{ mS}$, $C_2=100 \text{ nF}$, $E=1 \text{ V}$. In the 3-D phase portraits, the units on the V_1 and V_2 axes are volts, and the units on the I_3 axis is milliamps.

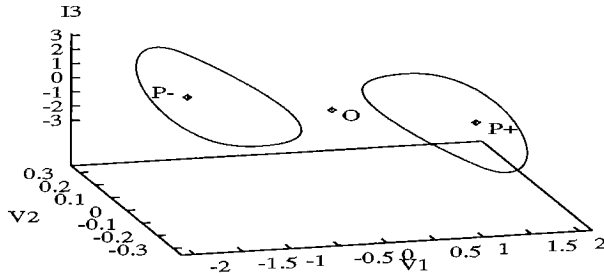
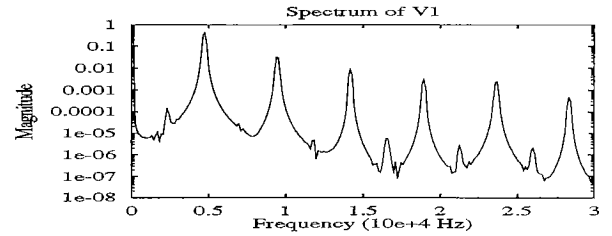
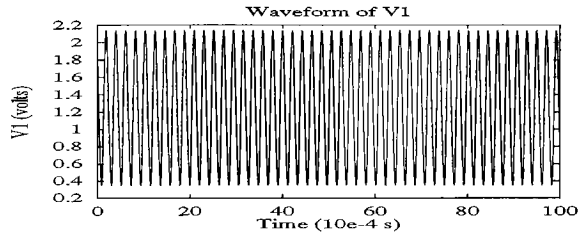

2.1 Control parameter: $C1 = 11.364nF$.
Eigenvalues: $\mu_1 = 2.07 \times 10^4$, $\mu_2 = -9.68 \times 10^3 + 2.98 \times 10^4j$, $\mu_3 = -9.68 \times 10^3 - 2.98 \times 10^4j$, $\nu_1 = -3.77 \times 10^4$, $\nu_2 = 1.27 \times 10^3 + 3.27 \times 10^4j$, $\nu_3 = 1.27 \times 10^3 - 3.27 \times 10^4j$.

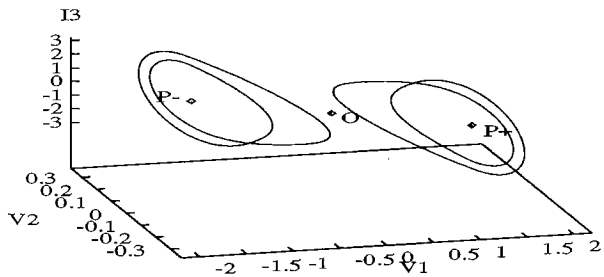
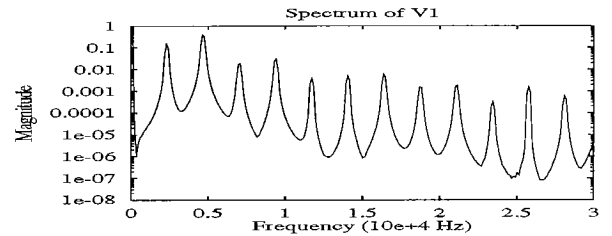
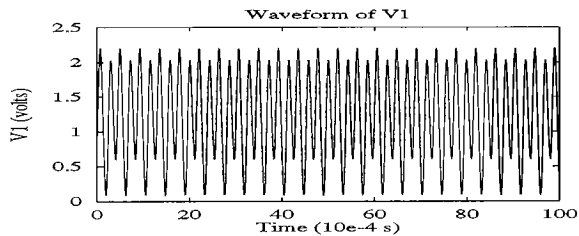

2.2 Control parameter: $C1 = 11.050nF$.
Eigenvalues: $\mu_1 = 2.15 \times 10^4$, $\mu_2 = -9.27 \times 10^3 + 2.97 \times 10^4j$, $\mu_3 = -9.27 \times 10^3 - 2.97 \times 10^4j$, $\nu_1 = -3.88 \times 10^4$, $\nu_2 = 1.40 \times 10^3 + 3.26 \times 10^4j$, $\nu_3 = 1.40 \times 10^3 - 3.26 \times 10^4j$.

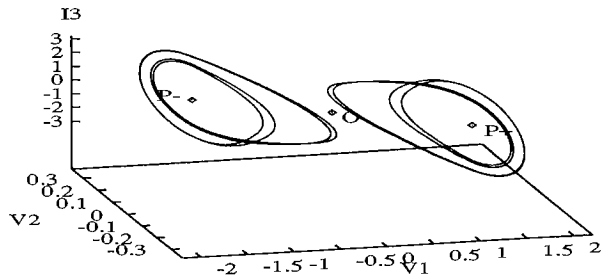
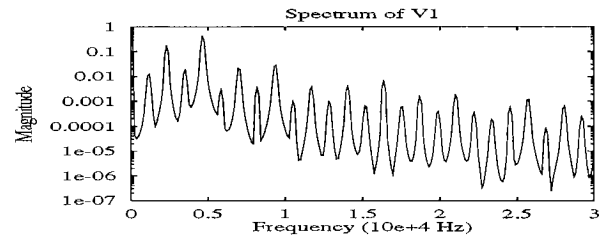
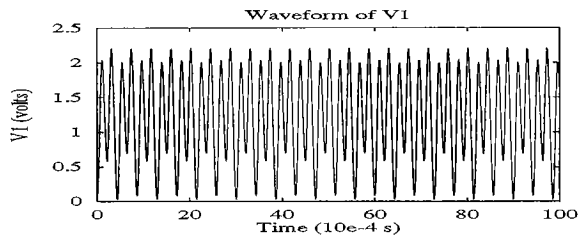

2.3 Control parameter: $C1 = 10.965nF$.
Eigenvalues: $\mu_1 = 2.17 \times 10^4$, $\mu_2 = -9.32 \times 10^3 + 2.96 \times 10^4j$, $\mu_3 = -9.32 \times 10^3 - 2.96 \times 10^4j$, $\nu_1 = -3.91 \times 10^4$, $\nu_2 = 1.51 \times 10^3 + 3.26 \times 10^4j$, $\nu_3 = 1.51 \times 10^3 - 3.26 \times 10^4j$.

Table 2 (Continued.)

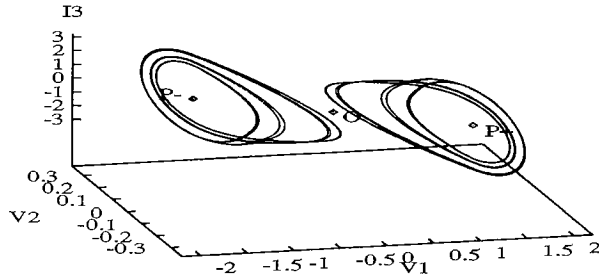
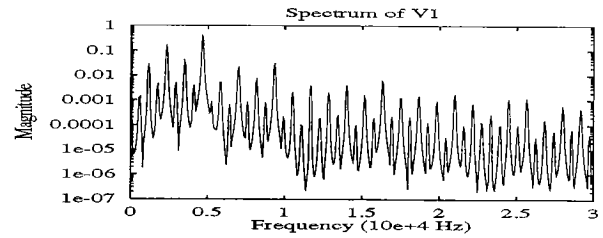
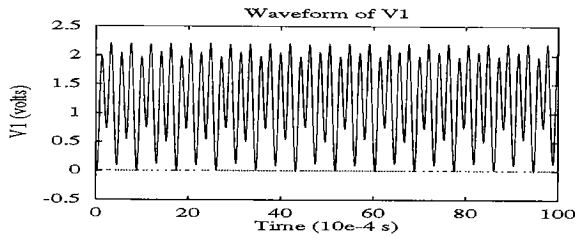

2.4 Control parameter: $C1 = 10.915nF$.
Eigenvalues: $\mu_1 = 2.18 \times 10^4$, $\mu_2 = -9.36 \times 10^3 + 2.96 \times 10^4j$, $\mu_3 = -9.36 \times 10^3 - 2.96 \times 10^4j$, $\nu_1 = -3.93 \times 10^4$, $\nu_2 = 1.54 \times 10^3 + 3.26 \times 10^4j$, $\nu_3 = 1.54 \times 10^3 - 3.26 \times 10^4j$.

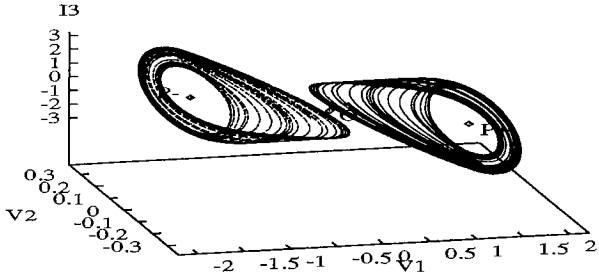
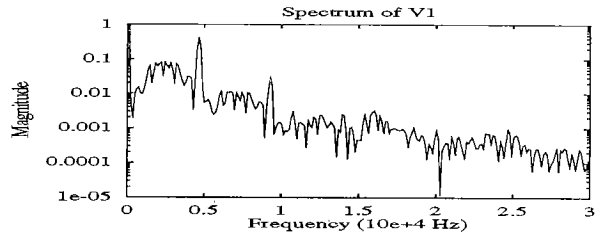
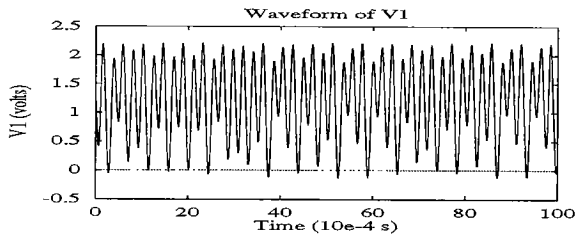

2.5 Control parameter: $C1 = 10.753nF$.
Eigenvalues: $\mu_1 = 2.22 \times 10^4$, $\mu_2 = -9.46 \times 10^3 + 2.95 \times 10^4j$, $\mu_3 = -9.46 \times 10^3 - 2.95 \times 10^4j$, $\nu_1 = -3.99 \times 10^4$, $\nu_2 = 1.64 \times 10^3 + 3.26 \times 10^4j$, $\nu_3 = 1.64 \times 10^3 - 3.26 \times 10^4j$.

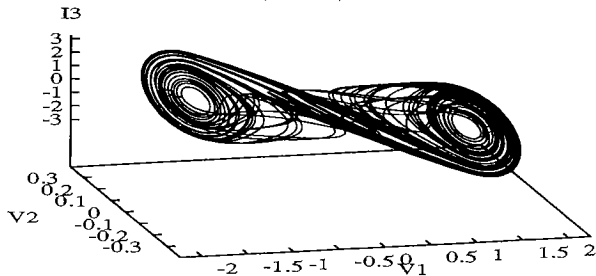
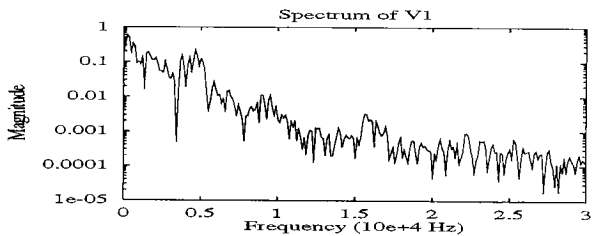
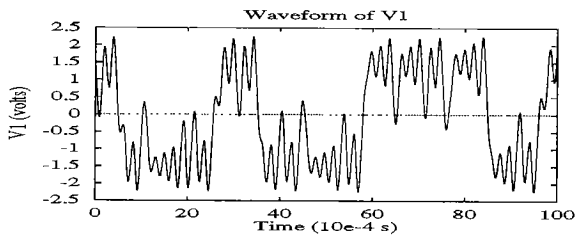

2.6 Control parameter: $C1 = 10.204nF$.
Eigenvalues: $\mu_1 = 2.37 \times 10^4$, $\mu_2 = -9.84 \times 10^3 + 2.91 \times 10^4j$, $\mu_3 = -9.84 \times 10^3 - 2.91 \times 10^4j$, $\nu_1 = -4.20 \times 10^4$, $\nu_2 = 1.99 \times 10^3 + 3.26 \times 10^4j$, $\nu_3 = 1.99 \times 10^3 - 3.26 \times 10^4j$.

Table 3 Intermittency route to Chaos. The fixed parameters are $C_2=1 \mu\text{F}$, $C_1=-13.33 \text{ nF}$, $R=1 \text{ k}\Omega$, $R_0=-100 \Omega$, $G_a=-0.98 \text{ mS}$, $G_b=-2.4 \text{ mS}$, $E=1 \text{ V}$. In the 3-D phase portraits, the units on the V_1 and V_2 axes are volts, and the units on the I_3 axis is milliamps. In 3.2, the asymmetric attractor and its twin are both shown in the phase portrait.

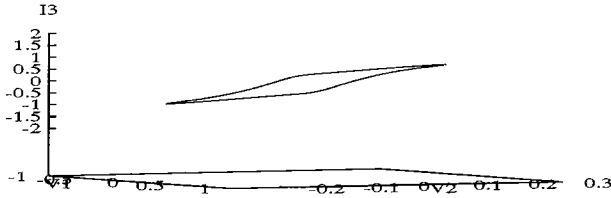
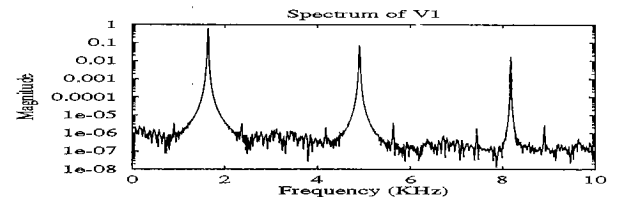
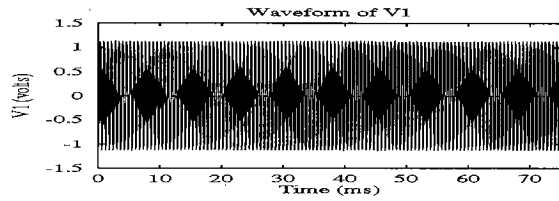

3.1 Control parameter: $L = 16.67\text{mH}$.

Eigenvalues: $\mu_1 = 4.19 \times 10^3$, $\mu_2 = 1.16 \times 10^3 + 1.12 \times 10^4 j$, $\mu_3 = 1.16 \times 10^3 - 1.12 \times 10^4 j$, $\nu_1 = -1.04 \times 10^5$, $\nu_2 = 2.14 \times 10^3 + 6.74 \times 10^3 j$, $\nu_3 = 2.14 \times 10^3 - 6.74 \times 10^3 j$.

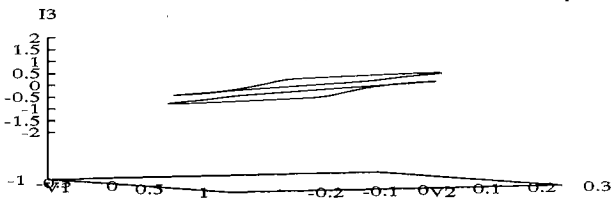
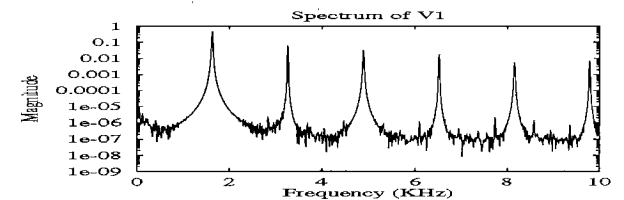
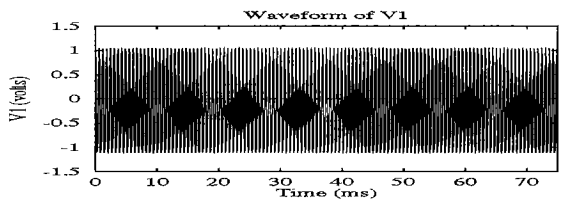

3.2 Control parameter: $L = 22.32\text{mH}$.

Eigenvalues: $\mu_1 = 3.44 \times 10^3$, $\mu_2 = 770 + 1.07 \times 10^4 j$, $\mu_3 = 770 - 1.07 \times 10^4 j$, $\nu_1 = -1.04 \times 10^5$, $\nu_2 = 1.38 \times 10^3 + 5.96 \times 10^3 j$, $\nu_3 = 1.38 \times 10^3 - 5.96 \times 10^3 j$.

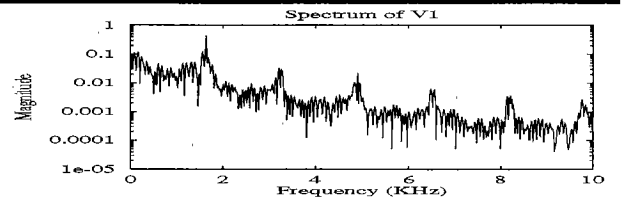
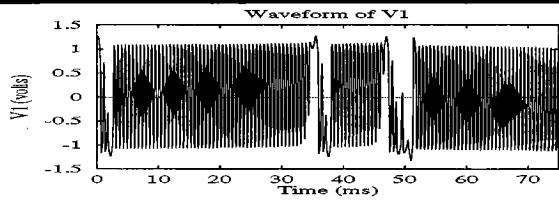

3.3 Control parameter: $L = 22.73\text{mH}$.

Eigenvalues: $\mu_1 = 3.40 \times 10^3$, $\mu_2 = 751 + 1.07 \times 10^4 j$, $\mu_3 = 751 - 1.07 \times 10^4 j$, $\nu_1 = -1.04 \times 10^5$, $\nu_2 = 1.34 \times 10^3 + 5.91 \times 10^3 j$, $\nu_3 = 1.34 \times 10^3 - 5.91 \times 10^3 j$.

Table 3 (Continued.)

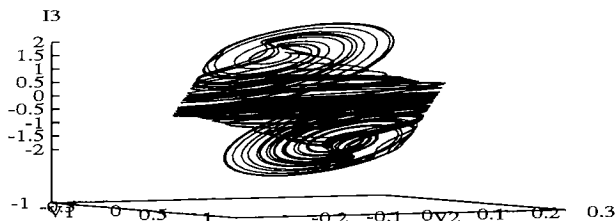
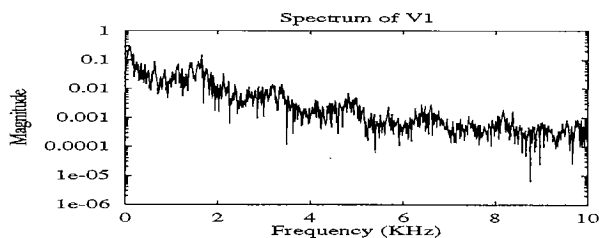
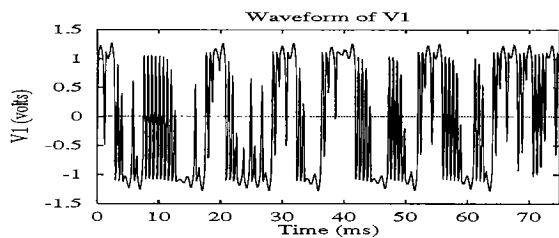

3.4 Control parameter: $L = 28.80mH$.

Eigenvalues: $\mu_1 = 2.88 \times 10^3$, $\mu_2 = 548 + 1.03 \times 10^4j$, $\mu_3 = 548 - 1.03 \times 10^4j$, $\nu_1 = -1.04 \times 10^5$, $\nu_2 = 874 + 5.31 \times 10^3j$, $\nu_3 = 874 - 5.31 \times 10^3j$.

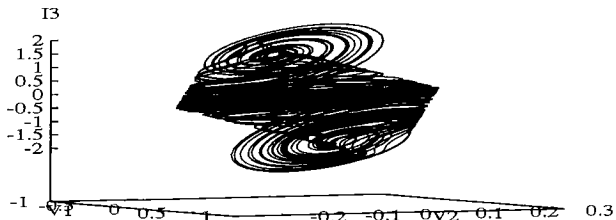
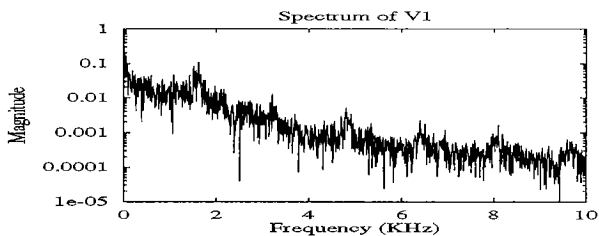
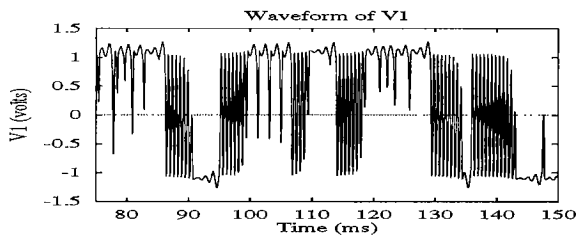

3.5 Control parameter: $L = 31.50mH$.

Eigenvalues: $\mu_1 = 2.70 \times 10^3$, $\mu_2 = 489 + 1.02 \times 10^4j$, $\mu_3 = 489 - 1.02 \times 10^4j$, $\nu_1 = -1.04 \times 10^5$, $\nu_2 = 725 + 5.10 \times 10^3j$, $\nu_3 = 725 - 5.10 \times 10^3j$.

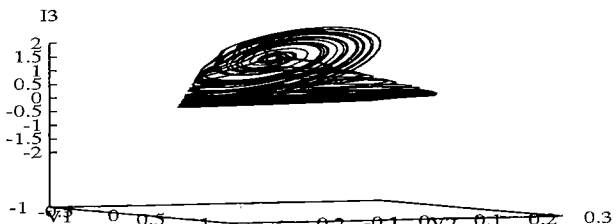
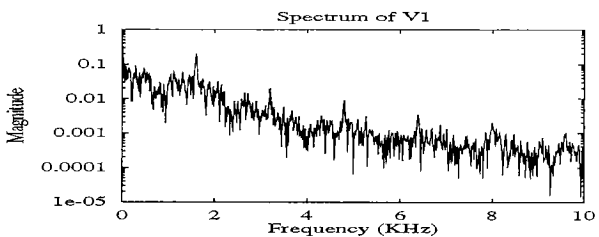
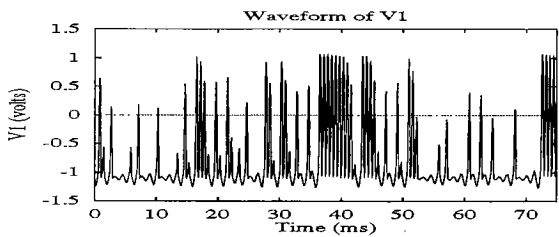

3.6 Control parameter: $L = 32.00mH$.

Eigenvalues: $\mu_1 = 2.67 \times 10^3$, $\mu_2 = 480 + 1.02 \times 10^4j$, $\mu_3 = 480 - 1.02 \times 10^4j$, $\nu_1 = -1.04 \times 10^5$, $\nu_2 = 700 + 5.06 \times 10^3j$, $\nu_3 = 700 - 5.06 \times 10^3j$.

Table 4 Torus breakdown route to Chaos. The fixed parameters are $C_2=1 \mu\text{F}$, $R=-1 \text{ k}\Omega$, $R_0=0.651 \Omega$, $G_a=0.856 \text{ mS}$, $G_b=1.1 \text{ mS}$, $L=0.667 \text{ mH}$, $E=1 \text{ V}$. In the 3-D phase portraits, the units on the V_1 and V_2 axes are volts, and the units on the I_3 axis is milliamps.

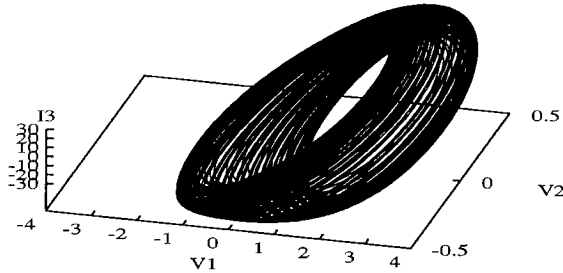
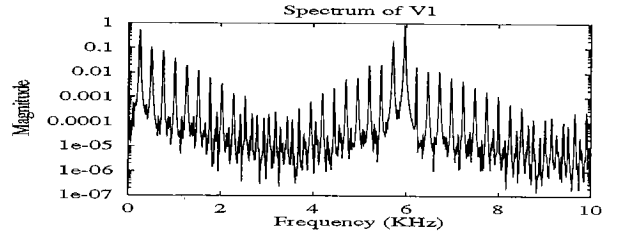
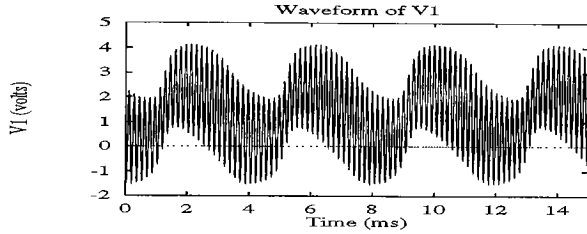

4.1 Control parameter: $C_1 = 10nF$.

Eigenvalues: $\mu_1 = 1.53 \times 10^4$, $\mu_2 = -459 + 3.76 \times 10^4 j$, $\mu_3 = -459 - 3.76 \times 10^4 j$, $\nu_1 = -1.06 \times 10^4$, $\nu_2 = 311 + 3.75 \times 10^4 j$, $\nu_3 = 311 - 3.75 \times 10^4 j$.

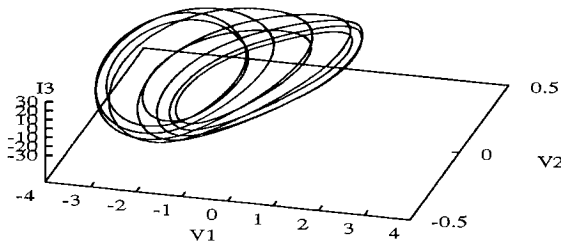
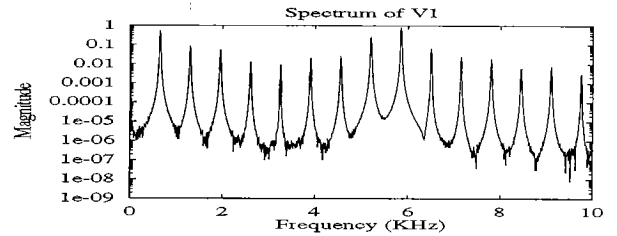
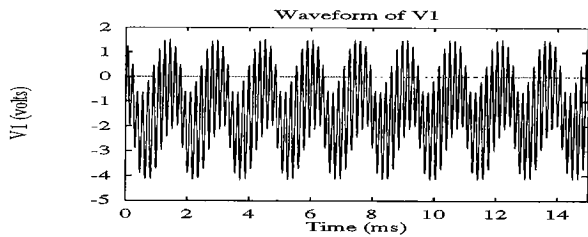

4.2 Control parameter: $C_1 = 6.0nF$.

Eigenvalues: $\mu_1 = 2.61 \times 10^4$, $\mu_2 = -1.03 \times 10^3 + 3.72 \times 10^4 j$, $\mu_3 = -1.03 \times 10^3 - 3.72 \times 10^4 j$, $\nu_1 = -1.82 \times 10^4$, $\nu_2 = 797 + 3.69 \times 10^4 j$, $\nu_3 = 797 - 3.69 \times 10^4 j$.

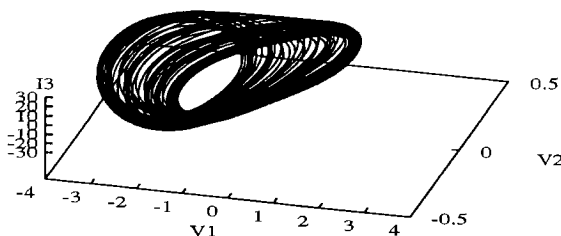
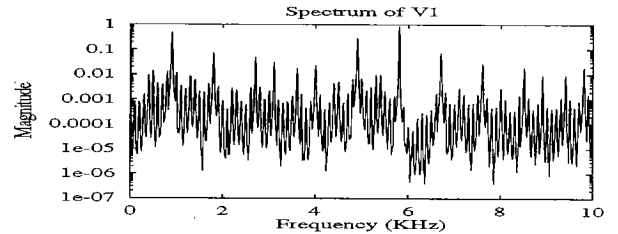
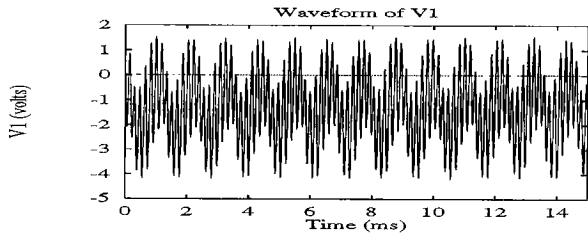

4.3 Control parameter: $C_1 = 5.1nF$.

Eigenvalues: $\mu_1 = 3.08 \times 10^4$, $\mu_2 = -1.26 \times 10^3 + 3.71 \times 10^4 j$, $\mu_3 = -1.26 \times 10^3 - 3.71 \times 10^4 j$, $\nu_1 = -2.17 \times 10^4$, $\nu_2 = 1.04 \times 10^3 + 3.67 \times 10^4 j$, $\nu_3 = 1.04 \times 10^3 - 3.67 \times 10^4 j$.

Table 4 (Continued.)

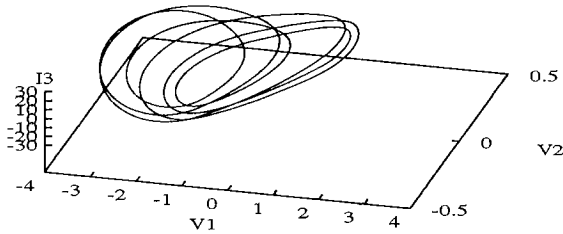
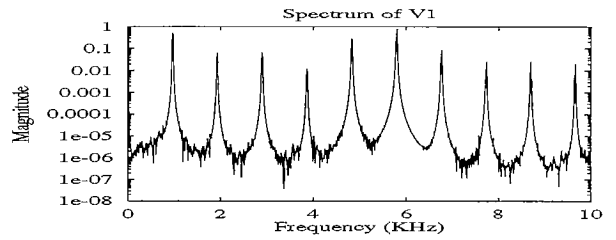
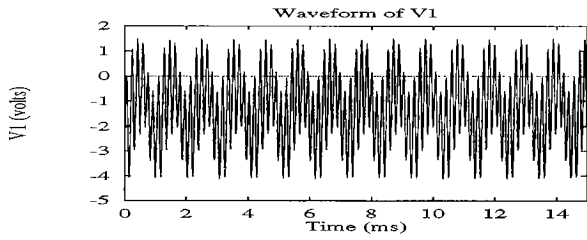

4.4 Control parameter: $C_1 = 5.0nF$.

Eigenvalues: $\mu_1 = 3.14 \times 10^4$, $\mu_2 = -1.29 \times 10^3 + 3.71 \times 10^4j$, $\mu_3 = -1.29 \times 10^3 - 3.71 \times 10^4j$, $\nu_1 = -2.21 \times 10^4$, $\nu_2 = 1.08 \times 10^3 + 3.67 \times 10^4j$, $\nu_3 = 1.08 \times 10^3 - 3.67 \times 10^4j$.

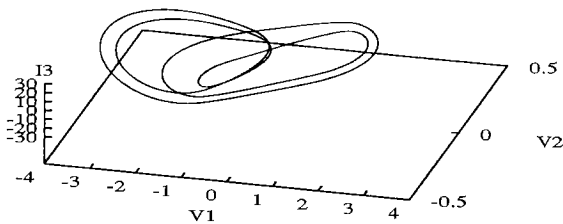
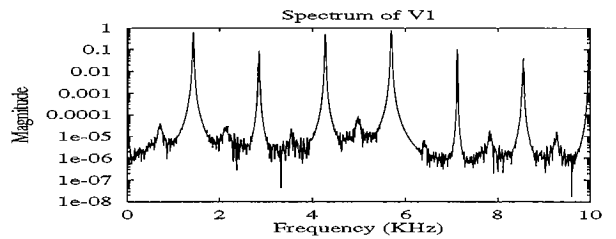
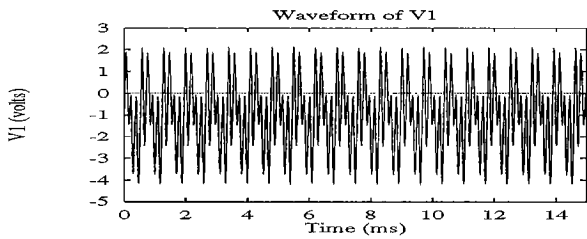

4.5 Control parameter: $C_1 = 3.5nF$.

Eigenvalues: $\mu_1 = 4.49 \times 10^4$, $\mu_2 = -1.85 \times 10^3 + 3.71 \times 10^4j$, $\mu_3 = -1.85 \times 10^3 - 3.71 \times 10^4j$, $\nu_1 = -3.21 \times 10^4$, $\nu_2 = 1.77 \times 10^3 + 3.64 \times 10^4j$, $\nu_3 = 1.77 \times 10^3 - 3.64 \times 10^4j$.

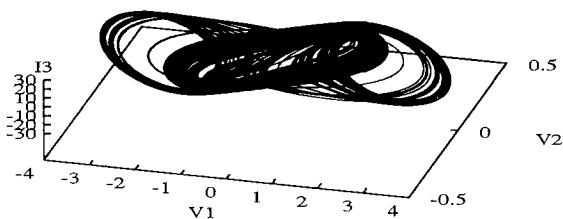
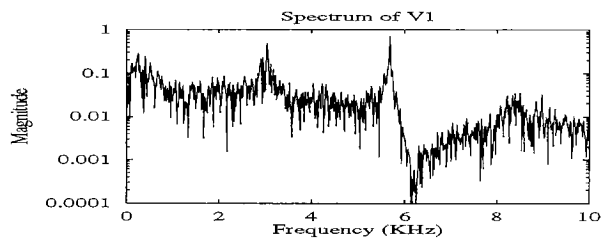
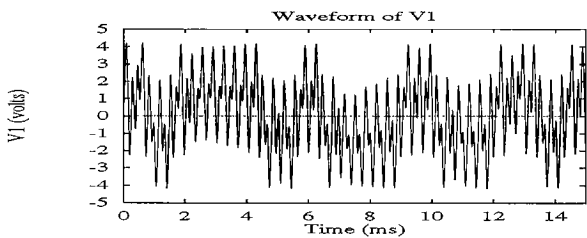

4.6 Control parameter: $C_1 = 2.94nF$.

Eigenvalues: $\mu_1 = 5.33 \times 10^4$, $\mu_2 = -2.12 \times 10^3 + 3.72 \times 10^4j$, $\mu_3 = -2.12 \times 10^3 - 3.72 \times 10^4j$, $\nu_1 = -3.83 \times 10^4$, $\nu_2 = 2.15 \times 10^3 + 3.63 \times 10^4j$, $\nu_3 = 2.15 \times 10^3 - 3.63 \times 10^4j$.

$$= \begin{bmatrix} 1 & 0 & 0 \\ -10 & 0 & -1 \\ 110 & 1 & 10.7 \end{bmatrix} \quad (52)$$

and

$$\tilde{K} = \begin{bmatrix} 1 & 0 & 0 \\ -11.000042 & -0.098858 & 0 \\ 120.703293 & 1.385072 & 3.010693 \end{bmatrix} \quad (53)$$

where ε , a , and b are parameters from Ref.(38).

To verify that the 2 strange attractors in Fig. 3 are in fact one and *the same* attractor expressed in different coordinate systems, we multiply the coordinates $(\tilde{x}_1, \tilde{x}_2, \tilde{x}_3) = (v_1, v_2, i_3)$ of the time series of the attractor in Fig. 3(b) from the canonical Chua's circuit by the matrix T , and obtain the attractor shown in Fig. 3(a), as expected.

Example 2: Period-Doubling Route to Chaos

Table 2 shows the waveform and spectrum of $v_1(t)$ and its associated attractor obtained from previous publications on Chua's circuit. Table 2.1 shows a pair of periodic orbits which bifurcated from two stable equilibrium points $P^+ \in D_1$ and $P^- \in D_{-1}$, via Hopf bifurcation. As we vary a single parameter C_1 from $C_1=11.364$ nF down to $C_1=10.204$ nF, while keeping all other parameters fixed, we obtain the well-known *period-doubling route* to chaos, as shown in Tables 2.2 (period 2), 2.3 (period 4), 2.4 (period 8), 2.5 (spiral attractor), and 2.6 (Double Scroll Attractor). If we substitute the eigenvalues associated with each attractor in Table 2 into Eqs.(15), (16), we would obtain the corresponding parameters indicated in this table (scaled by a factor to obtain reasonable circuit parameters). Notice that $R_0=0$ in each case, as expected.

Example 3: Intermittency Route to Chaos

Table 3 shows the waveform and spectrum of $v_1(t)$ and its associated attractor obtained by mapping corresponding attractors from the earlier canonical Chua's circuit in Ref.(44). Using the eigenvalues calculated from Eq.(3) in Ref.(44) for the attractors shown in Figs. 3(a), (b), (c), (d), and (e) of Ref.(44), we obtain the corresponding attractors using the unfolded canonical Chua's circuit, as shown in Table 3.1, 3.2, 3.3, 3.5, and 3.6, Note that while some of these attractors may not look very similar to their corresponding attractors in Fig. 3 of Ref. (44), they are in fact related by the transformation matrix T defined in Eq. (48). Table 3.4 provides another attractor not given in Ref.(44) but which illustrates the evolution of the intermittency phenomenon in greater detail.

Example 4: Torus Breakdown Route to Chaos

Table 4 shows the waveform and spectrum of $v_1(t)$ and its associated attractor obtained by mapping corresponding attractors from the *torus circuit* given in

Ref.(35).[†] Using the eigenvalues calculated from Eq. (1) of Ref.(35) for the attractors shown in Fig. 5 of Ref.(35), we found these eigenvalues belong to the set of unrealizable eigenvalues (as defined by Eq.(17)). Using the slightly perturbed eigenvalues shown in Table 4 (scaled to obtain reasonable parameter values), we obtain the corresponding attractors shown in Table 4.1-4.6.

5.2 Mapping Chaotic Systems from Family \mathcal{C}

Consider the chaotic feedback system given by Brockett in Ref.(42), and its strange attractor given in Fig. 9 (page 936), which we reproduce in Fig. 4(a). Using the system parameters provided in Ref.(42), we have calculated the following eigenvalues:

$$\left. \begin{aligned} \mu_1 &= 0.721965, \quad \mu_2 = -0.860982 + j1.3236, \\ \mu_3 &= -0.860982 - j1.3236 \\ \nu_1 &= -1.61109, \quad \nu_2 = 0.305544 + j1.46327, \\ \nu_3 &= 0.305544 - j1.46327 \end{aligned} \right\} \quad (54)$$

The corresponding equivalent eigenvalue parameters

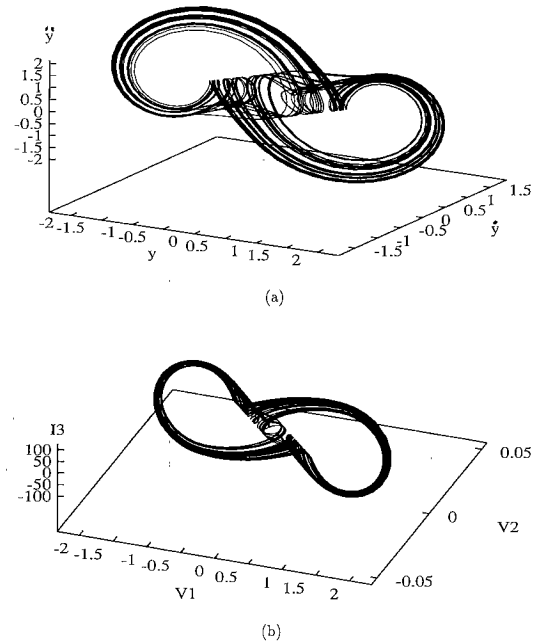
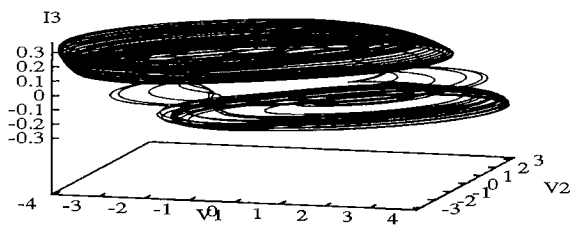
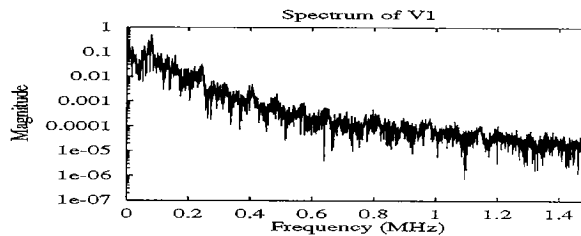
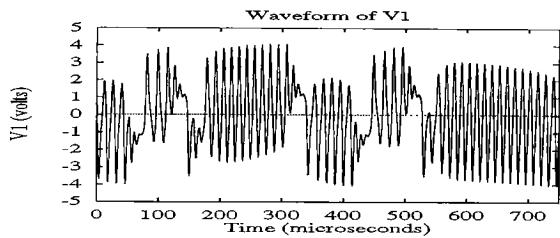

Fig. 4 (a) Strange attractor reproduced from Fig.9 (p.936) of Ref.(42).
 (b) Qualitatively similar Equivalent strange attractor generated by the unfolded Chua's Circuit with parameters given by Eq.(58).

[†] This circuit was discovered and studied extensively by R. Tokunaga. The authors' order in Ref.(35) was based on Matsumoto's tradition.

Table 5 A gallery of attractors from the unfolded Chua's circuit. In the 3-D phase portraits, the units on the V_1 and V_2 axes are volts, and the units on the I_3 axis is milliamps. $E=1$ V.



5.1 $C_1 = -768.6pF$, $C_2 = 1nF$, $L = -73.5mH$,
 $R = 1K\Omega$, $R_0 = 2.18K\Omega$, $G_a = 0.169mS$, $G_b = -0.477mS$.

Eigenvalues: $\mu_1 = 7.84 \times 10^5$, $\mu_2 = -3.37 \times 10^5$,
 $\mu_3 = 1.03 \times 10^5$, $\nu_1 = 1.52 \times 10^4$, $\nu_2 = -1.53 \times 10^5 + 7.61 \times 10^5j$, $\nu_3 = -1.53 \times 10^5 - 7.61 \times 10^5j$.

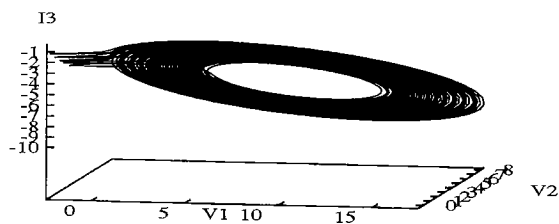
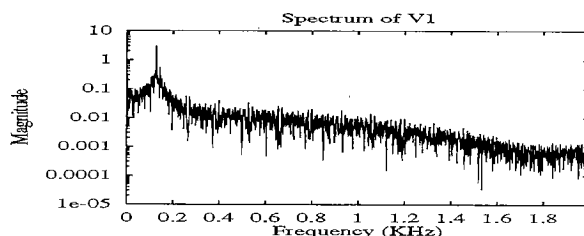
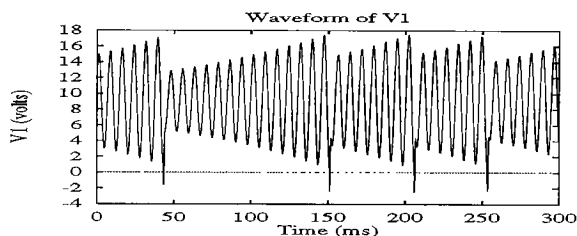

5.2 $C_1 = 57.5nF$, $C_2 = -1\mu F$, $L = -708mH$,
 $R = 1K\Omega$, $R_0 = 740\Omega$, $G_a = -1.525mS$, $G_b = -0.458mS$.

Eigenvalues: $\mu_1 = 5.56 \times 10^3$, $\mu_2 = 3.61 \times 10^3$,
 $\mu_3 = 1.57 \times 10^3$, $\nu_1 = -7.40 \times 10^3$, $\nu_2 = -18.2 + 854j$, $\nu_3 = -18.2 - 854j$.

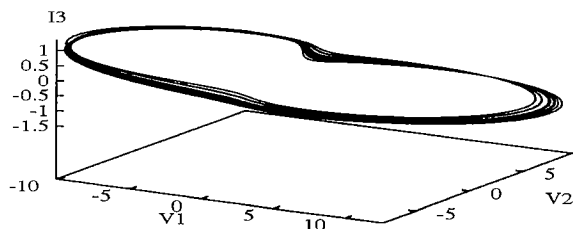
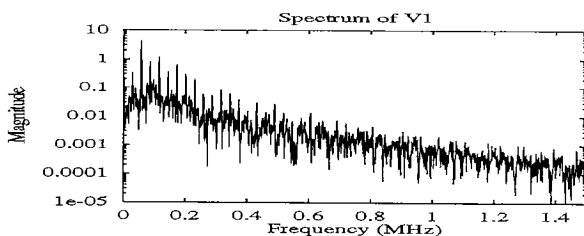
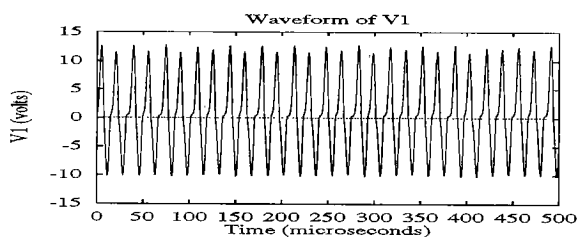

5.3 $C_1 = 735pF$, $C_2 = -1nF$, $L = 11.44mH$,
 $R = 1K\Omega$, $R_0 = 3.56K\Omega$, $G_a = 1.292mS$, $G_b = -0.497mS$.

Eigenvalues: $\mu_1 = -2.75 \times 10^6$, $\mu_2 = 7.30 \times 10^5$,
 $\mu_3 = -4.08 \times 10^5$, $\nu_1 = -2.67 \times 10^5$, $\nu_2 = 1.36 \times 10^5 + 7.38 \times 10^5j$, $\nu_3 = 1.36 \times 10^5 - 7.38 \times 10^5j$.

Table 5 (Continued.)

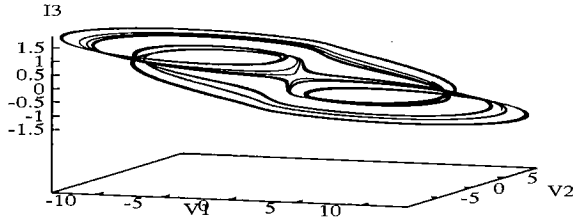
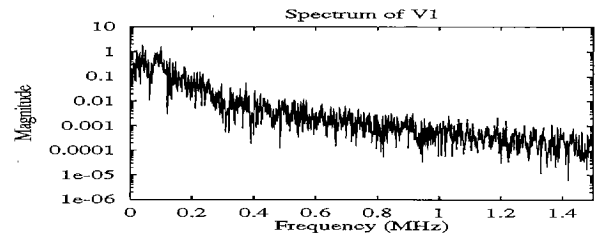
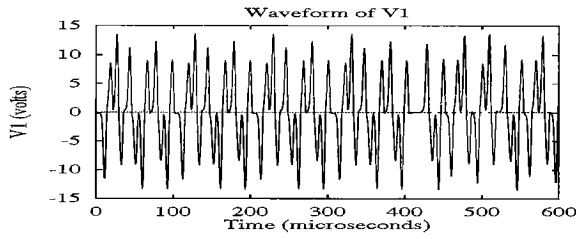

5.4 $C_1 = 684pF$, $C_2 = -1nF$, $L = 10.6mH$, $R = 1K\Omega$, $R_0 = 3.43K\Omega$, $G_a = 1.219mS$, $G_b = -0.514mS$.

Eigenvalues: $\mu_1 = -2.86 \times 10^6$, $\mu_2 = 7.22 \times 10^5$, $\mu_3 = -4.27 \times 10^5$, $\nu_1 = -2.79 \times 10^5$, $\nu_2 = 1.22 \times 10^5 + 7.85 \times 10^5 j$, $\nu_3 = 1.22 \times 10^5 - 7.85 \times 10^5 j$.

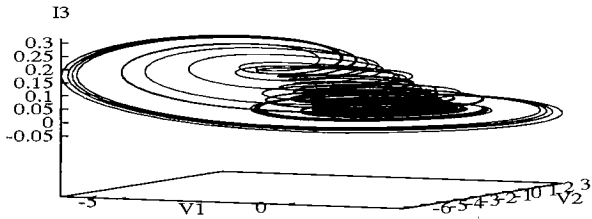
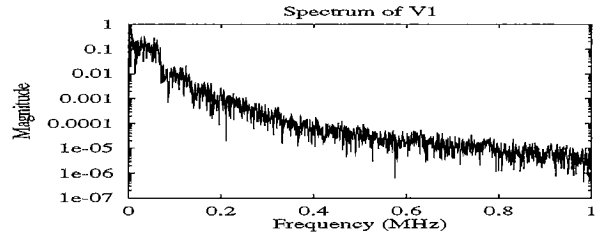
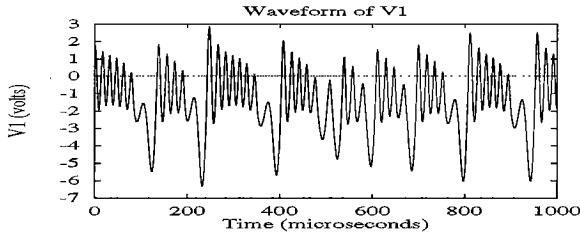

5.5 $C_1 = 811pF$, $C_2 = -1nF$, $L = -138mH$, $R = 1K\Omega$, $R_0 = 12.1K\Omega$, $G_a = -0.177mS$, $G_b = -0.02mS$.

Eigenvalues: $\mu_1 = 5.28 \times 10^4$, $\mu_2 = 1.00 \times 10^4 + 4.72 \times 10^5 j$, $\mu_3 = 1.00 \times 10^4 - 4.72 \times 10^5 j$, $\nu_1 = -2.08 \times 10^5$, $\nu_2 = 4.35 \times 10^4 + 1.73 \times 10^5 j$, $\nu_3 = 4.35 \times 10^4 - 1.73 \times 10^5 j$.

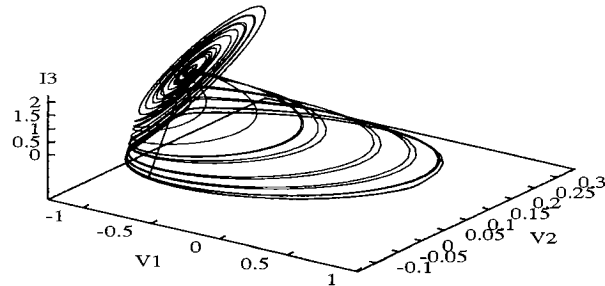
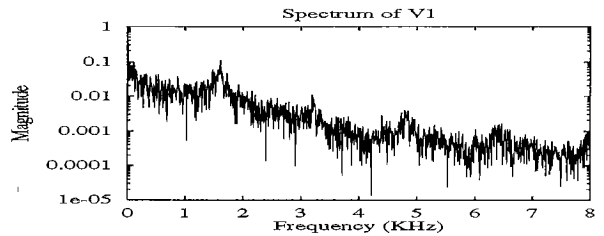
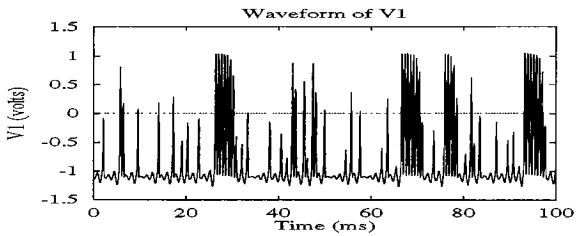

5.6 $C_1 = -13.33nF$, $C_2 = 1\mu F$, $L = 32mH$, $R = 1K\Omega$, $R_0 = -100\Omega$, $G_a = -0.98mS$, $G_b = -2.4mS$.

Eigenvalues: $\mu_1 = 2.67 \times 10^3$, $\mu_2 = 480 + 1.02 \times 10^4 j$, $\mu_3 = 480 - 1.02 \times 10^4 j$, $\nu_1 = -1.04 \times 10^5$, $\nu_2 = 700 + 5.06 \times 10^3 j$, $\nu_3 = 700 - 5.06 \times 10^3 j$.

Table 5 (Continued.)

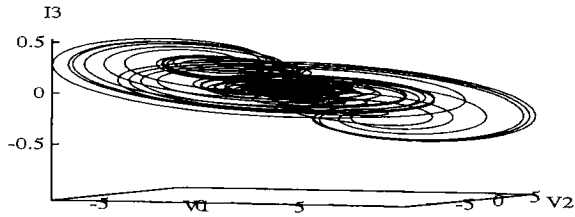
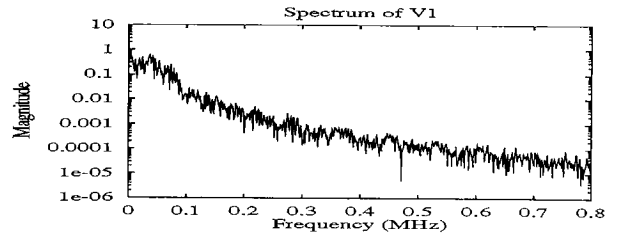
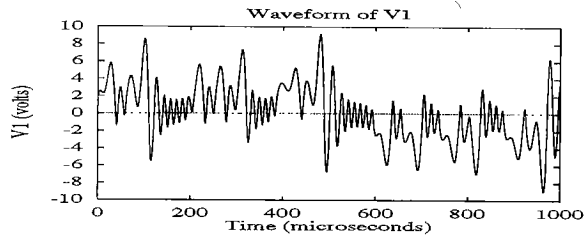

5.7 $C_1 = 758pF$, $C_2 = -1nF$, $L = -79.6mH$,
 $R = 1K\Omega$, $R_0 = 10.6K\Omega$, $G_a = -0.2241mS$,
 $G_b = -0.02811mS$.

Eigenvalues: $\mu_1 = 8.75 \times 10^4$, $\mu_2 = 1.10 \times 10^4 + 5.50 \times 10^5 j$, $\mu_3 = 1.10 \times 10^4 - 5.50 \times 10^5 j$,
 $\nu_1 = -2.64 \times 10^5$, $\nu_2 = 5.74 \times 10^4 + 1.98 \times 10^5 j$,
 $\nu_3 = 5.74 \times 10^4 - 1.98 \times 10^5 j$.

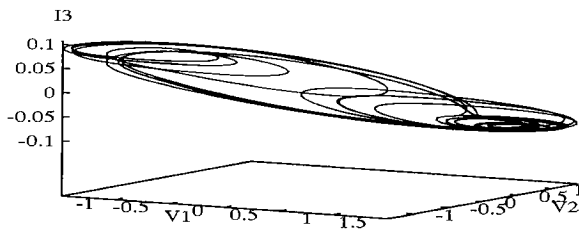
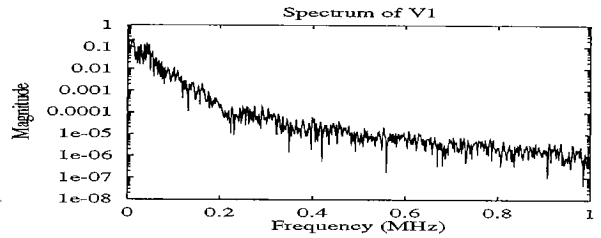
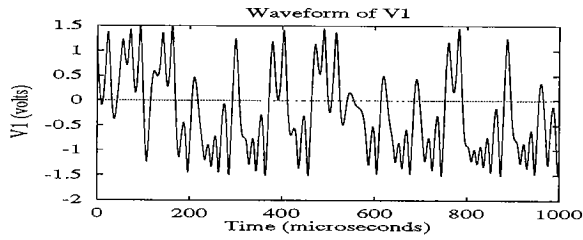

5.8 $C_1 = -702pF$, $C_2 = 1nF$, $L = 33.96mH$, $R = 1K\Omega$,
 $R_0 = 11.0K\Omega$, $G_a = -0.0715mS$, $G_b = -0.1817mS$.

Eigenvalues: $\mu_1 = 1.33 \times 10^5$, $\mu_2 = -6.72 \times 10^4 + 2.00 \times 10^5 j$, $\mu_3 = -6.72 \times 10^4 - 2.00 \times 10^5 j$,
 $\nu_1 = -2.03 \times 10^5$, $\nu_2 = 2.25 \times 10^4 + 4.93 \times 10^5 j$,
 $\nu_3 = 2.25 \times 10^4 - 4.93 \times 10^5 j$.

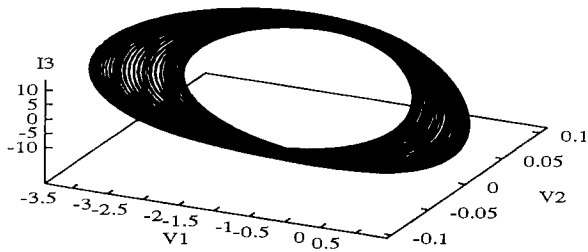
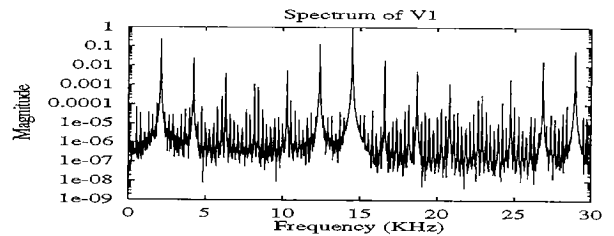
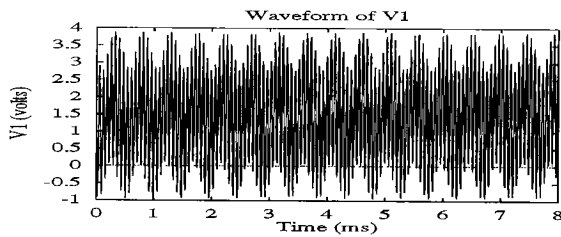

5.9 $C_1 = 0.56nF$, $C_2 = 1\mu F$, $L = 0.1mH$,
 $R = 1K\Omega$, $R_0 = 0\Omega$, $G_a = -1.026mS$, $G_b = -0.982mS$.

Eigenvalues: $\mu_1 = 5.39 \times 10^4$, $\mu_2 = -4.21 \times 10^3 + 9.28 \times 10^4 j$, $\mu_3 = -4.21 \times 10^3 - 9.28 \times 10^4 j$,
 $\nu_1 = -3.81 \times 10^4$, $\nu_2 = 2.48 \times 10^3 + 9.18 \times 10^4 j$,
 $\nu_3 = 2.48 \times 10^3 - 9.18 \times 10^4 j$.

Table 5 (Continued.)

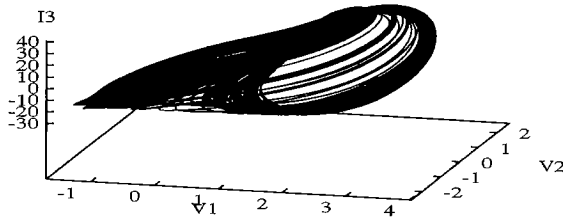
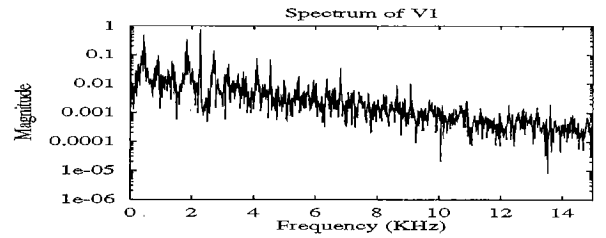
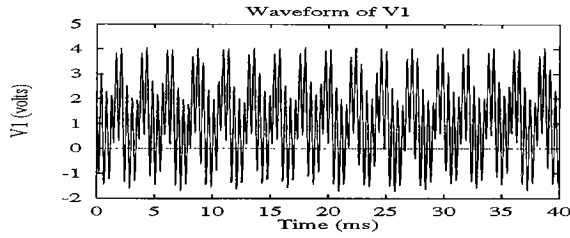

5.10 $C_1 = 75.1nF$, $C_2 = 1\mu F$, $L = 4.7mH$,
 $R = -1K\Omega$, $R_0 = 4.41\Omega$, $G_a = -0.474mS$,
 $G_b = 2.039mS$.
Eigenvalues: $\mu_1 = 2.01 \times 10^4$, $\mu_2 = -197 + 1.44 \times 10^4 j$,
 $\mu_3 = -197 - 1.44 \times 10^4 j$, $\nu_1 = -1.43 \times 10^4$,
 $\nu_2 = 244 + 1.43 \times 10^4 j$, $\nu_3 = 244 - 1.43 \times 10^4 j$.

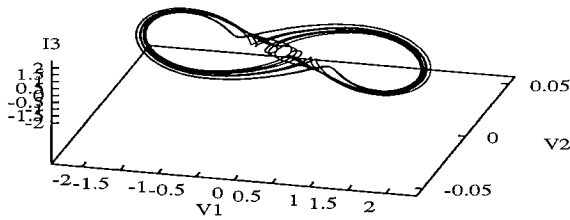
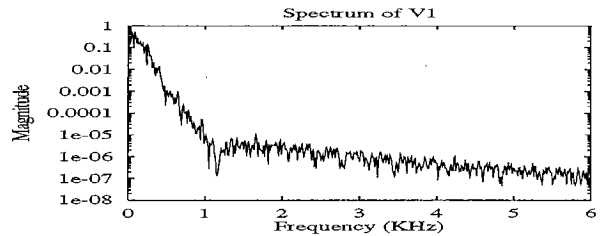
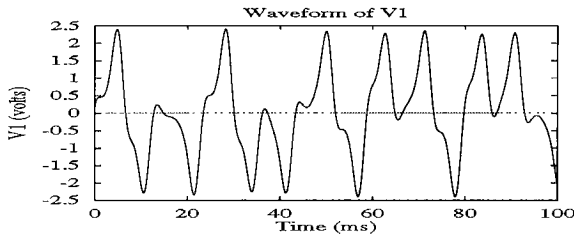

5.11 $C_1 = 19.21nF$, $C_2 = 1\mu F$, $L = 18.42mH$,
 $R = -1K\Omega$, $R_0 = 18.4\Omega$, $G_a = 1.018mS$, $G_b = 1.02mS$.
Eigenvalues: $\mu_1 = 794$, $\mu_2 = -865 + 1.36 \times 10^4 j$,
 $\mu_3 = -865 - 1.36 \times 10^4 j$, $\nu_1 = -1.61 \times 10^3$, $\nu_2 = 287 + 1.40 \times 10^3 j$,
 $\nu_3 = 287 - 1.40 \times 10^3 j$.

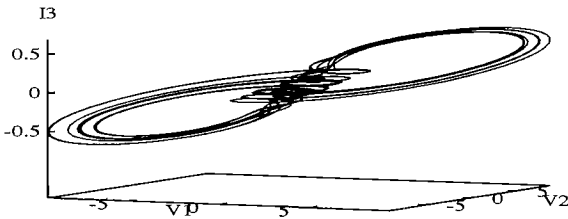
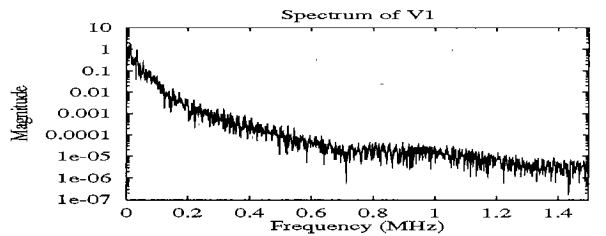
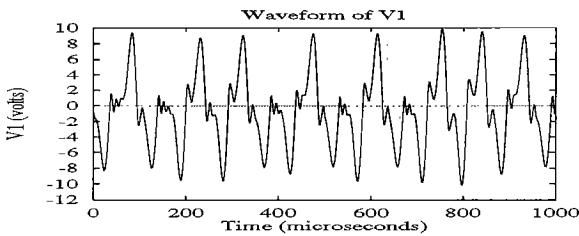

5.12 $C_1 = -641pF$, $C_2 = 1nF$, $L = 63.9mH$,
 $R = -1K\Omega$, $R_0 = -10.1K\Omega$, $G_a = 0.2438mS$,
 $G_b = 0.0425mS$.
Eigenvalues: $\mu_1 = 1.09 \times 10^5$, $\mu_2 = -6.54 \times 10^4 + 6.14 \times 10^5 j$,
 $\mu_3 = -6.54 \times 10^4 - 6.14 \times 10^5 j$, $\nu_1 = -4.05 \times 10^5$,
 $\nu_2 = 3.45 \times 10^4 + 1.75 \times 10^5 j$,
 $\nu_3 = 3.45 \times 10^4 - 1.75 \times 10^5 j$.

Table 5 (Continued.)

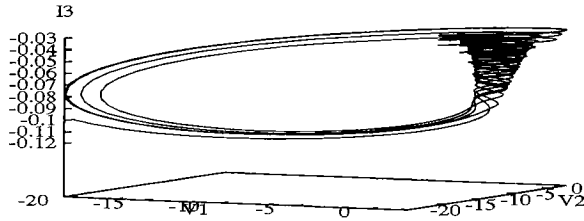
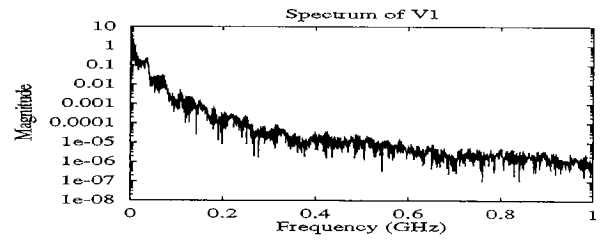
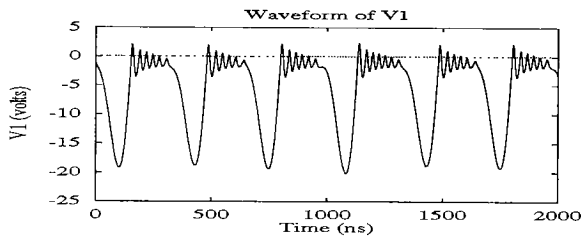

5.13 $C_1 = -0.92pF$, $C_2 = 1pF$, $L = 10.32mH$, $R = -1K\Omega$, $R_0 = -75.6K\Omega$, $G_a = 0.09411mS$, $G_b = 0.1899\mu S$.

Eigenvalues: $\mu_1 = 6.39 \times 10^6$, $\mu_2 = 8.14 \times 10^6 + 3.2 \times 10^8j$, $\mu_3 = 8.14 \times 10^6 - 3.2 \times 10^8j$, $\nu_1 = -9.46 \times 10^7$, $\nu_2 = 7.56 \times 10^6 + 3.23 \times 10^7j$, $\nu_3 = 7.56 \times 10^6 - 3.23 \times 10^7j$.

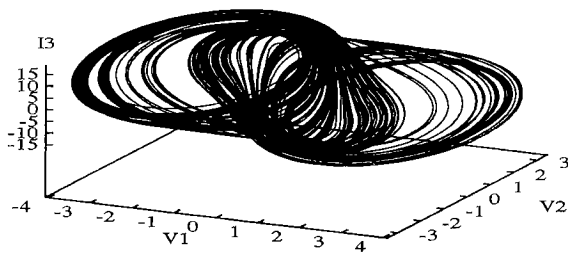
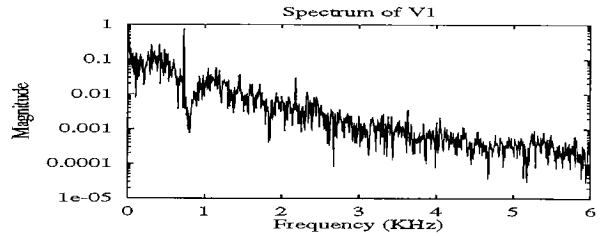
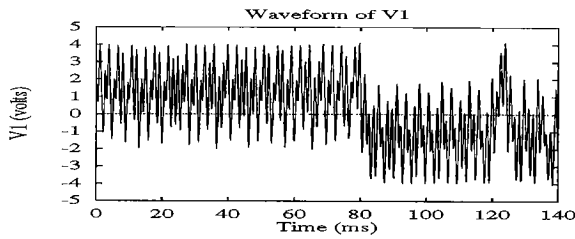

5.14 $C_1 = 269.6nF$, $C_2 = 1\mu F$, $L = 41.5mH$, $R = 1K\Omega$, $R_0 = -35.7\Omega$, $G_a = -2.764mS$, $G_b = 0.1805mS$.

Eigenvalues: $\mu_1 = 6.86 \times 10^3$, $\mu_2 = -226 + 4.65 \times 10^3j$, $\mu_3 = -226 - 4.65 \times 10^3j$, $\nu_1 = -4.84 \times 10^3$, $\nu_2 = 160 + 4.65 \times 10^3j$, $\nu_3 = 160 - 4.65 \times 10^3j$.

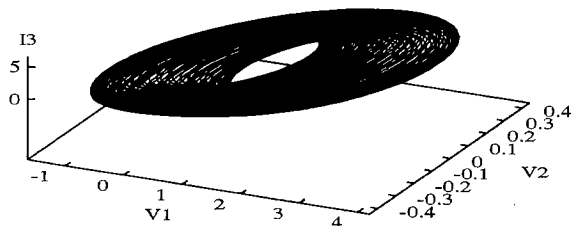
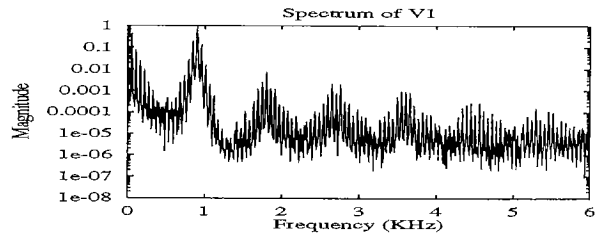
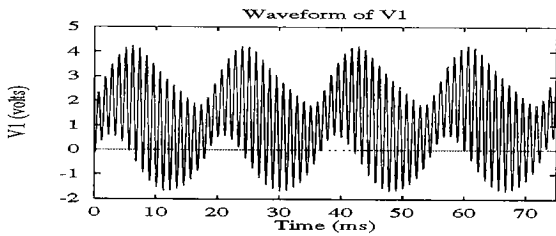

5.15 $C_1 = 31.72nF$, $C_2 = 1\mu F$, $L = 15.6mH$, $R = -1K\Omega$, $R_0 = 10.4\Omega$, $G_a = 0.9926mS$, $G_b = 1.023mS$.

Eigenvalues: $\mu_1 = 1.10 \times 10^3$, $\mu_2 = -226 + 5.70 \times 10^3j$, $\mu_3 = -226 - 5.70 \times 10^3j$, $\nu_1 = -781$, $\nu_2 = 195 + 5.65 \times 10^3j$, $\nu_3 = 195 - 5.65 \times 10^3j$.

Table 5 (Continued.)

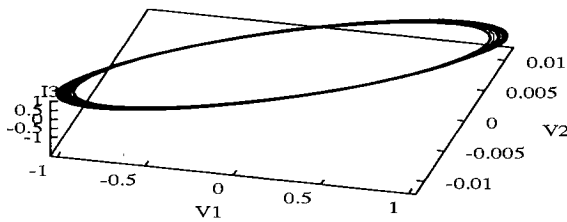
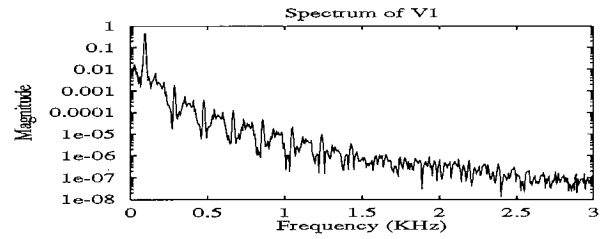
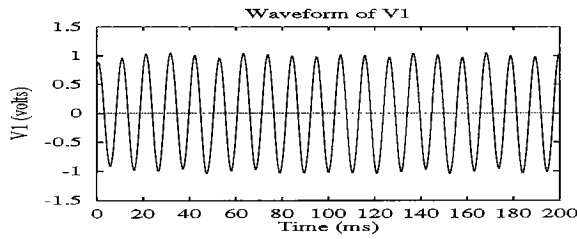

5.16 $C_1 = 9.98nF$, $C_2 = -1\mu F$, $L = 10.12mH$,
 $R = 1K\Omega$, $R_0 = 10.12\Omega$, $G_a = -0.99002mS$,
 $G_b = -0.9893mS$.

Eigenvalues: $\mu_1 = -1.6 \times 10^3$, $\mu_2 = 308 + 1.13 \times 10^3 j$, $\mu_3 = 308 - 1.13 \times 10^3 j$, $\nu_1 = 1.54 \times 10^3$,
 $\nu_2 = -1.31 \times 10^3 + 1.65 \times 10^3 j$, $\nu_3 = -1.31 \times 10^3 - 1.65 \times 10^3 j$.

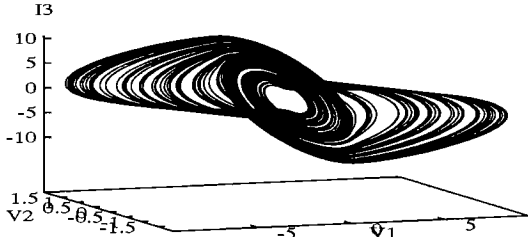
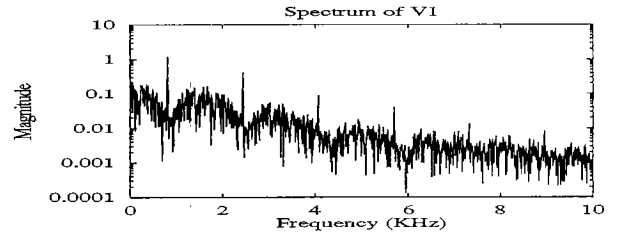
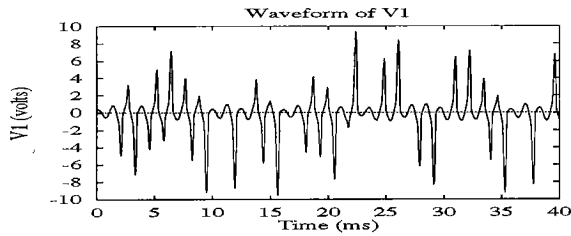

5.17 $C_1 = -13.33nF$, $C_2 = 1\mu F$, $L = 31.5mH$,
 $R = 1K\Omega$, $R_0 = -100\Omega$, $G_a = -2.4mS$, $G_b = -0.98mS$.

Eigenvalues: $\mu_1 = -1.04 \times 10^5$, $\mu_2 = 725 + 5.06 \times 10^3 j$, $\mu_3 = 725 - 5.06 \times 10^3 j$, $\nu_1 = 2.70 \times 10^3$,
 $\nu_2 = 489 + 1.02 \times 10^3 j$, $\nu_3 = 489 - 1.02 \times 10^3 j$.

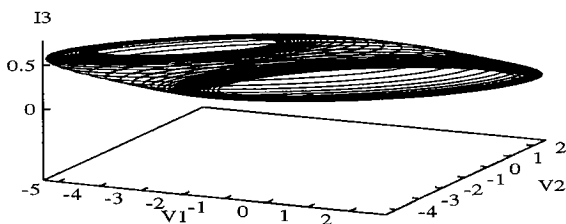
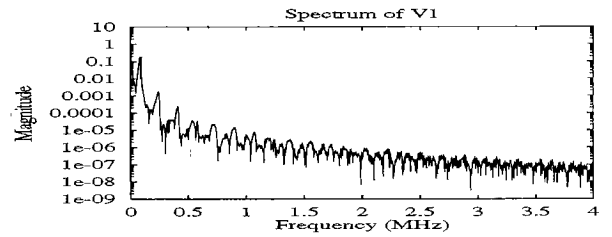
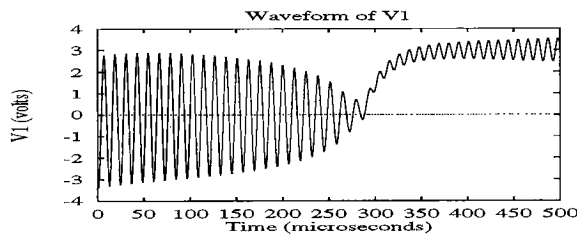

5.18 $C_1 = -621.5pF$, $C_2 = 1nF$, $L = 14.2mH$,
 $R = 1K\Omega$, $R_0 = 4.22K\Omega$, $G_a = -0.1392mS$,
 $G_b = -0.2175mS$.

Eigenvalues: $\mu_1 = 1.61 \times 10^4$, $\mu_2 = -3.68 \times 10^4 + 4.36 \times 10^5 j$, $\mu_3 = -3.68 \times 10^4 - 4.36 \times 10^5 j$,
 $\nu_1 = -4.46 \times 10^4$, $\nu_2 = 3.25 \times 10^3 + 5.86 \times 10^5 j$,
 $\nu_3 = 3.25 \times 10^3 - 5.86 \times 10^5 j$.

calculated from Eq.(3) are given by:

$$\left. \begin{aligned} p_1 &= -1, & p_2 &= 1.25, & p_3 &= 1.8 \\ q_1 &= -1, & q_2 &= 1.25, & q_3 &= -3.6 \end{aligned} \right\} \quad (55)$$

Observe that $p_1 = q_1$ and hence Brockett's system also belongs to the set \mathcal{E}_0 . To obtain a qualitatively similar strange attractor using the unfolded canonical Chua's circuit from Fig.2, we add a small perturbation $\delta p_1 = 0.05$ and $\delta q_1 = -0.05$ to obtain

$$\left. \begin{aligned} p'_1 &= -0.95, & p'_2 &= 1.25, & p'_3 &= 1.8 \\ q'_1 &= -1.05, & q'_2 &= 1.25, & q'_3 &= -3.6 \end{aligned} \right\} \quad (56)$$

These equivalent eigenvalue parameters corresponds to the following set of perturbed eigenvalues

$$\left. \begin{aligned} \mu'_1 &= 0.728163, & \mu'_2 &= -0.839081 + j1.3296, \\ \mu'_3 &= -0.839081 - j1.3296 \\ \nu'_1 &= -1.6337, & \nu'_2 &= 0.2918491 + j1.45548, \\ \nu'_3 &= 0.2918491 - j1.45548 \end{aligned} \right\} \quad (57)$$

Substituting Eq.(57) into Eqs.(15), (16), we obtain the following parameters for the equivalent "unfolded" canonical Chua's circuit:

$$\left. \begin{aligned} C_1 &= 1, & C_2 &= 52.25216, & L &= 0.0003479091 \\ R &= -0.01904761, & G &= -52.500025, \\ R_0 &= 0.0003498814, & G_a &= 53.44908, \\ G_b &= 53.54908 \end{aligned} \right\} \quad (58)$$

The strange attractor associated with the parameters in Eq.(58) is shown in Fig. 4(b). Again, to map Fig. 4 (b) into Fig. 4(a), we calculate the transformation matrix $T = K^{-1}\tilde{K}$ in Eq.(48), where

$$K = \begin{bmatrix} 1 & 0 & 0 \\ 0 & 1 & 0 \\ 0 & 0 & 1 \end{bmatrix} \quad (59)$$

and

$$\tilde{K} = \begin{bmatrix} 1 & 0 & 0 \\ -1.049053 & -52.500027 & 0 \\ 53.849583 & 2.326251 & -1.004744 \end{bmatrix} \quad (60)$$

Multiplying the coordinates $(\tilde{x}_1, \tilde{x}_2, \tilde{x}_3) = (v_1, v_2, i_b)$ of the time series of the attractor in Fig. 4(b) from the canonical Chua's circuit by the matrix T , we obtain an attractor which is *qualitatively similar* to that of Fig. 4(a), as expected.

5.3 A Zoo of Strange Attractors from Family \mathcal{E}

More than 30 non-periodic attractors from the

family \mathcal{E} of vector fields have been observed from many 3rd-order electronic circuits and systems, and from computer simulations. Table 5 shows a sample of some of these attractors which have been mapped into the unfolded canonical Chua's circuit of Fig. 2. Many of these attractors are mapped from those presented in Ref.(44). For example, Table 5.1, 5.2, 5.3, 5.4, 5.5, 5.7, 5.10, 5.12, and 5.13 correspond to the attractors given in Figs. 19, 18, 20, 8, 9, 12, 14, and 7 in Ref.(44) respectively. A gallery of 18 multi-color strange attractors from this table and table 1 (projected into the v_1 - v_2 plane) is shown in Table 6.

6. Concluding Remarks

All waveforms and attractors in this paper are calculated *numerically* using the user-friendly software package INSITE.⁽⁴⁸⁾ Since the circuit parameters for all attractors in Table 1-5 are given, and scaled to within the range of practical component values, *experimental* observations of these attractors can be made by building the unfolded Chua's Circuit with the corresponding circuit parameters. Those parameters which are negative can be realized with the help of a *negative impedance converter* (NIC) having a large enough linear dynamic range. The v_R - i_R characteristic of the nonlinear resistor (Chua's Diode⁽²¹⁾) can be realized by various nonlinear circuit synthesis techniques, such as those given in Refs.(49)-(52).

The circuit presented in Fig. 2 of this paper, as well as that given in Fig. 4 of Ref.(44) are both *canonical* and equivalent to each other. It is interesting to observe that these two circuits can be interpreted as a *global unfolding* of the 2 *chaotic* circuit candidates (Figs. 4(g) and (h) of Ref.(1), p. 252) which have been derived by a systematic nonlinear circuit synthesis procedure, as described in Ref.(1). Both unfoldings are obtained by adding a *linear* resistor in series with the inductor. In fact, many other canonical circuits can also be derived by connecting a linear resistor, by a plier or soldering-iron entry with other elements in these 2 circuits. Since all of these canonical circuits are equivalent to each other, *only one* circuit need to be studied in depth, at least from a theoretical point of view. Since many papers have already been published on Chua's circuit (Fig. 1), the unfolded Chua's circuit in Fig. 2 will be the circuit of choice in our future research on nonlinear *dynamics* of this circuit. Such a research program is important because any future result or breakthrough applies to the entire family \mathcal{E} of 21-parameter family of vector fields, including all of the chaotic circuits from Refs.(35)-(40), and chaotic systems from Refs.(41)-(43). In fact, it is natural for us to allow the scalar nonlinear function in Fig. 2 to be any piecewise continuous function (e.g., polynomial, signum function, etc.) which need not be piecewise-linear or symmetric. We conjecture that most auton-

Table 6 Gallery of selected strange attractors from Unfolded Chua's Circuit.

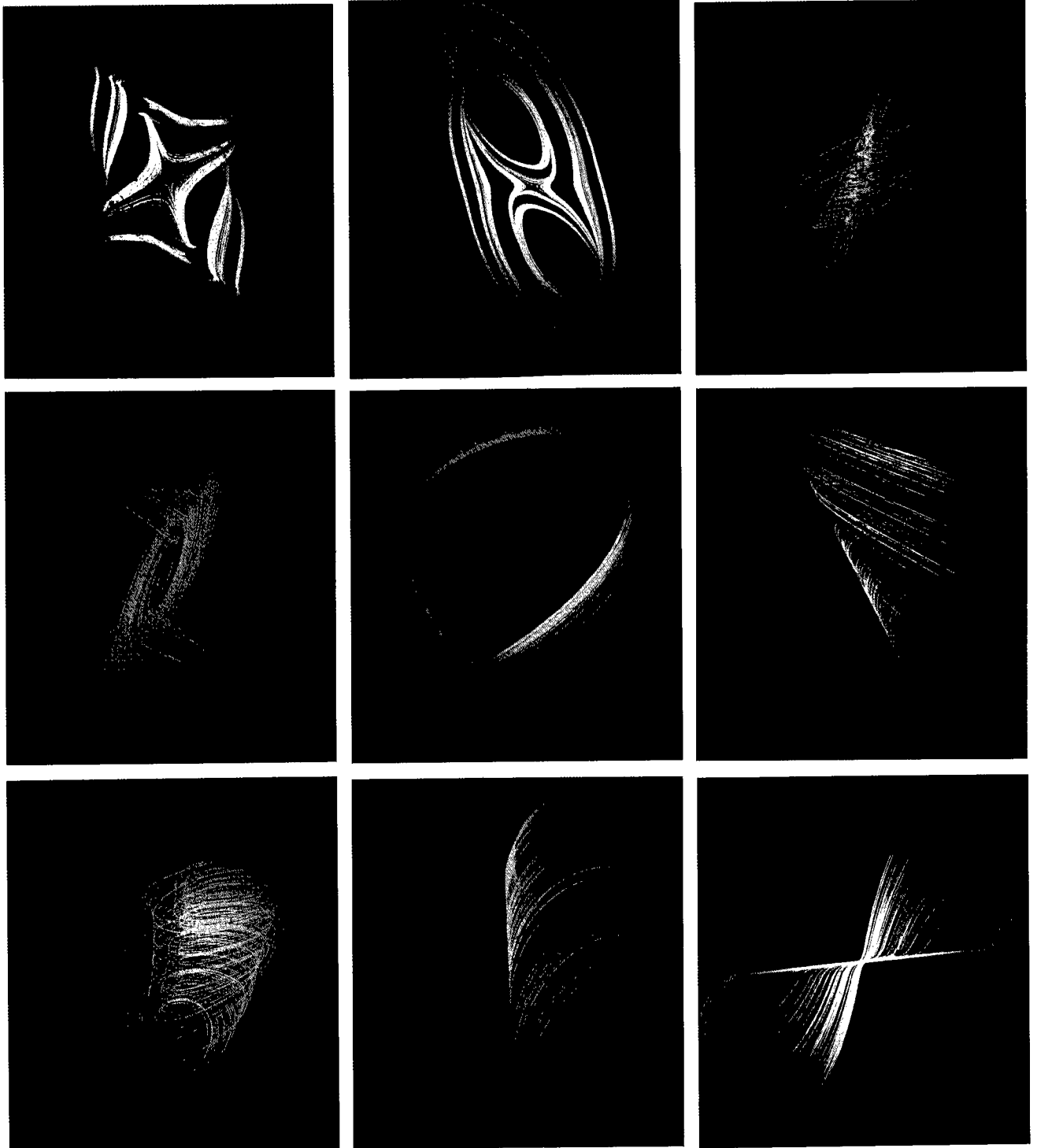
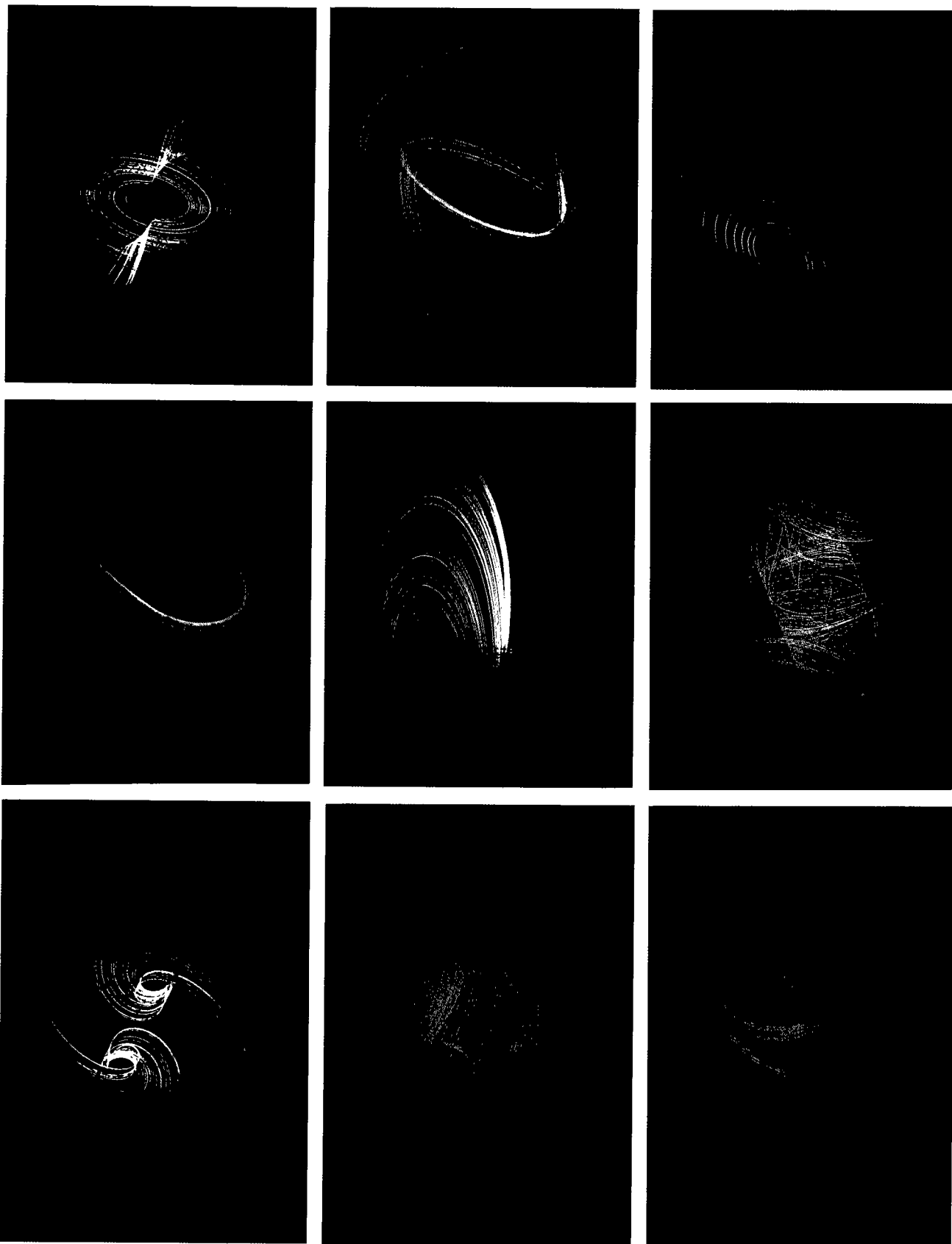

Table 6 (Continued.)



omous 3rd-order chaotic circuits and systems with polynomial, signum, and hysteretic nonlinearities can be accurately modeled by the above generalization. It is the *universality* and *unifying* potentials of the unfolded canonical Chua's circuit that has made it a fundamental and general tool for understanding and applying *chaotic dynamics* for future applications in science and technology.

7. Chronological Bibliography

Since the study of chaotic circuits and systems belonging to the 21-parameter family \mathcal{C} of vector fields reduces to the study of the unfolded Chua's circuit of Fig. 2, the following bibliography is included, in chronological order, for the convenience of future researchers of this circuit.

- Matsumoto, T., "A chaotic attractor from Chua's circuit," *IEEE Trans. Circuits & Syst.*, vol. CAS-31 no. 12 pp. 1055-1058, 1984.
- Zhong, G. Q. and Ayrom, F., "Experimental confirmation of chaos from Chua's circuit," *Int. J. Circuit Theory & Appl.*, vol. 13, no. 11, pp. 93-98, 1985.
- Zhong, G. Q. and Ayrom, F., "Periodicity and chaos in Chua's circuit," *IEEE Trans. Circuits & Syst.*, vol. CAS-32, no. 5, pp. 501-503, 1985.
- Matsumoto, T., Chua, L. O. and Komuro, M., "The Double Scroll," *IEEE Trans. Circuits & Syst.*, vol. CAS-32, no. 8, pp. 797-818, 1985.
- Ayrom, F. and Zhong, G. Q., "Chaos in Chua's circuit," *IEE Proceedings*, vol. 133, no. 6, pp. 307-312, 1986.
- Chua, L. O., Komuro, M. and Matsumoto, T., "The Double Scroll family, parts I and II," *IEEE Trans. Circuits & Syst.*, vol. CAS-33 no. 11, pp. 1073-1118, 1986.
- Kahlert, C. and Chua, L. O., "Transfer maps and return maps for piecewise-linear and three-region dynamical systems," *Int. J. Circuit Theory & Appl.*, vol. 15, no. 1, pp. 23-49, 1987.
- Ogorzalek, M. J., "Chaotic regions from Double Scroll," *IEEE Trans. Circuits & Syst.*, vol. CAS-34, no. 2, pp. 201-203, 1987.
- Broucke, M. E., "One-parameter bifurcation diagram for Chua's circuit," *IEEE Trans. Circuits & Syst.*, vol. CAS-34, no. 3, pp. 208-209, 1987.
- Yang, L. and Liao, Y. L., "Self-similar structures from Chua's circuit," *Int. J. Circuit Theory & Appl.*, vol. 15, no. 2, pp. 189-192, 1987.
- Wu, S., "Chua's circuit family," *Proceedings of the IEEE*, vol. 75, no. 8, pp. 1022-1032, 1987.
- Parker, T. S. and Chua, L. O., "The dual Double Scroll equation," *IEEE Trans. Circuits & Syst.*, vol. CAS-34, no. 9, pp. 1059-1073, 1987.
- Mees, A. I. and Chapman, P. B., "Homoclinic and heteroclinic orbits in the Double Scroll attractor," *IEEE Trans. Circuits & Syst.*, vol. CAS-34, no. 9, pp. 1115-1120, 1987.
- Kahlert, C., "The range of transfer and return maps in three-region piecewise-linear dynamical systems," *Int. J. Circuit Theory & Appl.*, vol. 16, no. 1, pp. 11-23, 1988.
- Kahlert, C., "Dynamics of the inclusions appearing in the return maps of Chua's circuit-1. the creation mechanism," *Int. J. Circuit Theory & Appl.*, vol. 16, no. 1, pp. 29-46, 1988.
- Komuro, M., "Normal forms of continuous piecewise-linear vector field and chaotic attractors: Part I," *Japan J. Appl. Math.*, vol. 5, no. 2, pp. 257-304, 1988.
- Komuro, M., "Normal forms of continuous piecewise-linear vector field and chaotic attractors: Part II," *Japan J. Appl. Math.*, vol. 5, no. 3, pp. 503-549, 1988.
- Kahlert, C., "The chaos producing mechanism in Chua's circuit," *Int. J. Circuit Theory & Appl.*, vol. 16, no. 2, pp. 227-232, 1988.
- Silva, C. P. and Chua, L. O., "The overdamped Double Scroll family," *Int. J. Circuit Theory & Appl.*, vol. 16, no. 3, pp. 233-302, 1988.
- Bartissol, P. and Chua, L. O., "The Double Hook," *IEEE Trans. Circuits & Syst.*, vol. CAS-35, no. 12, pp. 1512-1522, 1988.
- Huang, A., "A study of the chaotic phenomena in Chua's circuit," *In Proceedings of the ISCAS*, (Helsinki), pp. 273-276, 1988.
- Chua, L. O. and Lin, G. N., "Intermittency in a piecewise-linear circuit," *IEEE Trans. Circuits & Syst.*, vol. CAS-38, no. 5, pp. 510-520, 1990.
- Blazquez, C. M. and Tuma, E., "Dynamics of the Double Scroll circuit," *IEEE Trans. Circuits & Syst.*, vol. CAS-37, no. 5, pp. 589-593, 1990.
- Chua, L. O. and Lin, G. N., "Canonical realization of Chua's circuit family," *IEEE Trans. Circuits & Syst.*, vol. CAS-37, no. 7, pp. 885-902, 1990.
- Spany, V. and Pivka, L., "Boundary surfaces in sequential circuits," *Int. J. Circuit Theory & Appl.*, vol. 18, no. 4, pp. 349-360, 1990.
- Komuro, M., "Bifurcation equations of 3-dimensional piecewise-linear vector fields," In H. Kawakami, editor, *Bifurcation Phenomena in Nonlinear Systems and Theory of Dynamical Systems*, pp. 113-123, World Scientific, Singapore, 1990.
- Lozi, R. and Ushiki, S., "Co-existing chaotic attractors in Chua's circuit," *Int. J. of Bifurcation and Chaos*, vol. 1, no. 4, pp. 923-926, 1990.
- Lozi, R. and Ushiki, S., "Confinors and bounded-time patterns in Chua's circuit and the Double Scroll family," *Int. J. of Bifurcation and Chaos*, vol. 1, no. 1, pp. 119-138, 1991.
- Komuro, M., Tokunaga, R., Matsumoto, T. and Hotta, A., "Global bifurcation analysis of the Double Scroll circuit," *Int. J. of Bifurcation and Chaos*,

- vol. 1, no. 1, pp. 139–182, 1991.
- Chua, L. O. and Tichonicky, I., “1-D map for the double scroll family,” *IEEE Trans. circuits & syst.*, vol. CAS-38, pp. 233–243, Mar. 1991.
- Murali K. and Lakshmanan, M., “Bifurcation and chaos of the sinusoidally-driven Chua’s circuit,” *Int. J. of Bifurcation and Chaos.*, vol. 1, no. 2, pp. 369–384, 1991.
- Kahlert, C., “Heteroclinic orbits and scaled similar structures in the parameter space of the Chua oscillator,” In G. Baier and M. Klein, editors, *Chaotic Hierarchy*, pp. 209–234, World Scientific, Singapore, 1991.
- Suykens, J. and Vandewalle, J., “Quasilinear approach to nonlinear systems and the design of n -double scroll ($n=1, 2, 3, 4, \dots$),” *IEEE Proc. -G*, vol. 138, no. 5, pp. 595–603, Oct. 1991.
- Dabby D. S., *The buffalo horn and strange behavior in third order autonomous circuits*. Master’s thesis, Massachusetts Institute of Technology, Electrical Engineering and Computer Science, 1991.
- Genesio, R. and Tesi, A., “Harmonic balance approach for chaos prediction: the Chua’s circuit,” *Int. J. of Bifurcation and Chaos*, vol. 2, no. 1, pp. 63–79, 1992.
- Kennedy, M. P., “Robust op amp realization of Chua’s circuit,” *Frequenz*, vol. 46, no. 3–4, pp. 66–80, 1992.
- Anishchenko, V. S., Safonova, M. A. and Chua, L. O., “Stochastic resonance in Chua’s circuit,” *Int. J. of Bifurcation and Chaos*, vol. 2, no. 2, pp. 397–401, Jun. 1992.
- Perez-Munuzuri, V., Perez-Villar, V. and Chua, L. O., “Propagation failure in linear arrays of Chua’s circuits,” *Int. J. of Bifurcation and Chaos*, vol. 2, no. 2, pp. 403–406, Jun. 1992.
- Madan, R. N., “Observing and learning chaotic phenomena from Chua’s Circuit,” *Proc. of the 35th Midwest Symposium on Circuits and Systems*, Washington, DC., pp. 736–745, Aug. 10–12, 1992.
- Chua, L. O. and Huynh, L. T., “Bifurcation analysis of Chua’s Circuit,” *ibid.*, pp. 746–751.
- Chua, L. O., “A zoo of strange attractors from the canonical Chua’s Circuits,” *ibid.*, pp. 916–926.
- Chua, L. O., “A simple ODE with more than 20 strange attractors,” *Proc. of the World Congress of Nonlinear Analysts*, Tampa, Florida, Aug. 19–26, 1992.
- Ogorzalek, M. J., “Bifurcations and chaos for Chua’s circuit: A state-of-the-art review,” *ibid.*
- Dabrowski, A., Galias, Z. and Ogorzalek M. J., “A study of identification and control in a real implementation of Chua’s circuit,” *2-nd IFAC Workshop on System Structure and Control*, pp. 278–281, Prague, 1992.
- Belykh, V. N. and Chua, L. O., “New type of strange attractor from a geometric model of Chua’s circuit,” *Int. J. of Bifurcation and Chaos*, vol. 2, no. 3, pp. 697–704, Sep. 1992.
- Chua, L. O., Kocarev, L., Eckert, K. and Itoh, M., “Experimental synchronization in Chua’s circuit,” *Int. J. of Bifurcation and Chaos*, vol. 2, no. 3, pp. 705–708, Sep. 1992.
- Kocarev, L., Halle, K. S., Eckert, K., Chua, L. O. and Parlitz, U., “Experimental demonstration of secure communications via chaotic synchronization,” *Int. J. of Bifurcation and Chaos*, vol. 2, no. 3, pp. 709–713, Sep. 1992.
- Murali K. and Lakshmanan, M., “Transition from quasiperiodicity to chaos and devil’s staircase structures of the driven Chua’s circuit,” *Int. J. of Bifurcation and Chaos*, vol. 2, no. 3, pp. 621–632, 1992.
- Dabrowski, A., Galias, Z. and Ogorzalek, M. J., “A study of identification and control in a real implementation of Chua’s circuit,” *In Proc. 2nd IFAC Workshop on System Structure and Control*, pp. 278–281, (Prague, Czechoslovakia (invited paper)), Sep. 3–5, 1992.
- Halle, K. S., Chua, L. O., Anishchenko, V. S. and Safonova, M. A., “Signal amplification via chaos: Experimental evidence,” *Int. J. of Bifurcation and Chaos*, vol. 2, no. 4, pp. 1011–1020, 1992.
- Cruz, J. M. and Chua, L. O., “A CMOS IC nonlinear resistor for Chua’s Circuit,” *IEEE Trans. Circuits and Systems*, vol. 39, no. 12, pp. 985–995, Dec. 1992.
- Parlitz, U., Chua, L. O., Kocarev, L., Halle, K. S. and Shang, A., “Transmission of digital signals by chaotic synchronization,” *Int. J. of Bifurcation and Chaos*, vol. 2, no. 4, pp. 973–977, Dec. 1992.
- Elgar, S. and Chandran, V., “Higher-order spectral analysis to detect nonlinear interaction in measured time series and an application to Chua’s Circuit,” *Int. J. of Bifurcations and Chaos*, vol. 3, no. 1, Feb. 1993.
- Perez-Munuzuri, V., Gomez-Gesteira, M., Perez-Villar, V. and Chua, L. O., “Travelling wave propagation in a one-dimensional fluctuating medium,” *Int. J. of Bifurcation and Chaos*, vol. 3, no. 1, 1993.
- Madan, R. (Guest Editor), “Special Issue on Chua’s Circuit: A Paradigm for Chaos, Part 1,” *J. Circuit, Systems, and Computers*, vol. 3, no. 1, 1993.
- Madan, R. (Guest Editor), “Special Issue on Chua’s Circuit: A Paradigm for Chaos, Part 2,” *J. Circuit, Systems, and Computers*, vol. 3, no. 2, 1993.
- Shil’nikov, L. P., “Strange attractors and dynamical models,” *J. Circuits, Systems, and Computers*, vol. 3, no. 1, pp. 1–10, Mar. 1993.
- Brown, R., “From the Chua Circuit to the generalized Chua map,” *ibid.*, pp. 11–32.
- Elgar, S. and Kennedy, M. P., “Bispectral analysis of Chua’s Circuit,” *ibid.*, vol. 3, no. 1, pp. 33–48, Mar. 1993.
- Rodet, X., “Sound and music from Chua’s Circuit,” *ibid.*, pp. 49–61.
- Altman, E. J., “Bifurcation analysis of Chua’s Circuit

- with applications for low-level visual sensing," *ibid.*, pp. 63-92.
- Chua, L. O., Itoh, M., Kocarev, Lj. and Eckert, K., "Chaos synchronization in Chua's Circuit," *ibid.*, pp. 93-107.
- Johnson, G. A., Tigner, T. E. and Hunt, E. R., "Controlling chaos in Chua's Circuit," *ibid.*, pp. 109-117.
- Johnson, G. A. and Hunt, E. R., "Maintaining stability in Chua's Circuit driven into regions of oscillation and chaos," *ibid.*, pp. 119-123.
- Murali, K. and Lakshmanan, M., "Controlling of chaos in the driven Chua's Circuit," *ibid.*, pp. 125-137.
- Chen, G. and Dong, X., "Controlling Chua's Circuit," *ibid.*, pp. 139-149.
- Genesisio, R. and Tesi, A., "Distortion control of chaotic systems: The Chua's Circuit," *ibid.*, pp. 151-171.
- Hartley, T. T. and Mossayebi, F., "Control of Chua's Circuit," *ibid.*, pp. 173-194.
- Kapitaniak, T., "Targeting unstable stationary states of Chua's Circuit," *ibid.*, pp. 195-199.
- Glover, J. and Mees, A., "Reconstructing the dynamics of Chua's Circuit," *ibid.*, pp. 201-214.
- Perez-Munuzuri, V., Perez-Villar, V. and Chua, L. O., "Travelling wave front and its failure in a one-dimensional array of Chua's Circuits," *ibid.*, pp. 215-229.
- Mahla, A. I. and Badan Palhares, A. G., "Chua's Circuit with a discontinuous non-linearity," *ibid.*, pp. 231-237.
- Kocarev, Lj., Karadzinov, Lj. and Chua, L. O., "N-dimensional canonical Chua's Circuit," *ibid.*, pp. 239-258.
- Perez-Munuzuri, V., Perez-Villar, V. and Chua, L. O., "Autowaves for Image Processing on a Two-Dimensional CNN Array of Excitable Nonlinear Circuits: Flat and Wrinkled Labyrinths," *IEEE Trans. Circuits and Systems*, vol. CAS-40, pp. 174-181, Mar. 1993.
- Khibnik, A. J., Roose, D. and Chua, L. O., "On periodic orbits and homoclinic bifurcation in Chua's Circuit with smooth nonlinearity," *Int. J. of Bifurcation and Chaos*, vol. 3, no. 2, Apr. 1993.
- Lozi, R. and Ushiki, S., "Theory of confiners in Chua's Circuit: Accurate analysis of bifurcations and attractors," *ibid.*
- Misiurewicz, M., "Unimodal interval maps obtained from the modified Chua's Equations," *ibid.*
- Kapitaniak, T., Kocarev, Lj. and Chua, L. O., "Controlling chaos without feedback and control signals," *ibid.*
- Delgado-Restituto, M. and Rodriguez-Vazquez, A., "A CMOS monolithic Chua's Circuit," *J. Circuits, Systems, and Computers*, vol. 3, no. 2, Jun. 1993. See also the book edited by R. N. Madan, "Chua's Circuit: A Paradigm for Chaos," World Scientific Publishing Co., Singapore, 1993.
- Kennedy, M. P., Wu, C-W., Pau, S. and Tow, J., "Digital signal processor-based investigation of Chua's Circuit family," *ibid.*
- Deregel, P., "Chua's Oscillator: A zoo of attractors," *ibid.*
- Belykh, V. N. and Chua, L., "New type of strange attractor related to the Chua's Circuit," *ibid.*
- Genot, M., "Applications of 1-D map from Chua's Circuit," *ibid.*
- Ogorzalek, M. J. and Galias, Z., "Characterization of Chaos in Chua's Oscillator in terms of unstable periodic orbits," *ibid.*
- Kuznetsov, A. P., Kuznetsov, S. P., Sataev, I. R. and Chua, L. O., "Self-similarity and universality in Chua's Circuit via the approximate Chua's 1-D map," *ibid.*
- Pivka, L. and Spany, V., "Boundary surfaces and basin bifurcations in Chua's Circuit," *ibid.*
- Nasser, A. A. A., Hosny, E. E. and Sobhy, M. I., "Maximum dynamic range of bifurcations of Chua's Circuit," *ibid.*
- Rossetto, B., "Chua's Circuit as a slow-fast autonomous dynamical system," *ibid.*
- Leonov, G. A. and Smirnova, V. B., "Localization of attractors in multidimensional Chua's Circuit Equation," *ibid.*
- Parlitz, U., "Lyapunov exponents from Chua's Circuit," *ibid.*
- Biey, M., Chialina, S., Hasler, M. and Premoli, A., "Piecewise-linear analysis for Chua's Circuit family," *ibid.*
- Lindberg, E., "A note on the modelling and simulation of Chua's Circuit," *ibid.*
- Anishchenko, V. S., Safonova, M. A. and Chua, L. O., "Stochastic resonance in the nonautonomous Chua's Circuit," *ibid.*
- Belykh, V. N., Verichev, N. N., Kocarev, Lj. and Chua, L. O., "On chaotic synchronization in a linear array of Chua's Circuits," *ibid.*
- Zou, F. and Nossek, A., "An autonomous chaotic cellular neural network and Chua's Circuit," *ibid.*
- Blazquez C. M. and Tuma, E., "Dynamics of Chua's Circuit in a Banach space," *ibid.*
- Lukin, K. A., "High frequency oscillations from Chua's Circuit," *ibid.*
- Sharkovsky, A. N., Maistrenko, Yu., Deregel, P. and Chua, L. O., "Dry turbulence from a time-delayed Chua's Circuit," *ibid.*
- Bohme, F. and Schwarz, W., "Transformations of circuits belonging to Chua's Circuit family into nonlinear feedback loops made of passive RC-filter and active memoryless non-linearity," *ibid.*
- Guzelis, C., "Chaotic cellular neural networks made of Chua's Circuits," *ibid.*
- Cruz, J. M. and Chua, L. O. "An IC diode for Chua's

Circuit," *Int. J. Circuit Theory & Appl.*, vol. 21, no. 1, Mar. 1993.

Mayer-Kress, G., Choi, I., Weber, N., Bargar, R. and Hubler, A., "Musical Structures from Chua's Circuit," *IEEE Trans. Circuits & Syst.*, vol. 40, no. 10, Oct. 1993. Special Issue on "Chaos in Electronic Circuits."

Acknowledgement

I would like to thank Chai Wah Wu, Ljupco Kocarev and Anshan Huang for their assistance in the preparation of this manuscript.

References

- (1) Chua, L. O., "The genesis of Chua's circuit," *Archiv fur Elektronik und Ubertragungstechnik*, vol. 46, no. 4, pp. 250-257, 1992.
- (2) Matsumoto, T., "A chaotic attractor from Chua's circuit," *IEEE Trans. Circuits & Syst.*, vol. CAS-31, no. 12, pp. 1055-1058, 1984.
- (3) Zhong, G. Q. and Ayrom, F., "Experimental confirmation of chaos from Chua's circuit," *Int. J. Circuit Theory & Appl.*, vol. 13, no. 1, pp. 93-98, 1985.
- (4) Chua, L. O., Komuro, M. and Matsumoto, T., "The double scroll family, parts I and II," *IEEE Trans. Circuits & Syst.*, vol. 33, no. 11, pp. 1073-1118, 1986.
- (5) Madan, R. N. (Session Organizer), "Special session on Chua's circuit," *Proc. of the 35th Midwest Symposium on Circuits and Systems*, (Washington DC), Aug. 1992.
- (6) Madan, R. N. (Editor), "Special issue on Chua's circuit: A paradigm for chaos," *J. of Circuits, Systems, and Computers*, vol. 3, no. 1, Mar. 1993.
- (7) Madan, R. N. (Editor), "Special issue on Chua's circuit: A paradigm for chaos," *J. of Circuits, Systems, and Computers*, vol. 3, no. 2, Jun. 1993.
- (8) Chua, L. O., Kocarev, L., Eckert, K. and Itoh, M., "Experimental synchronization in Chua's circuit," *Int. J. of Bifurcation and Chaos*, vol. 2, no. 3, pp. 705-708, Sep. 1992.
- (9) Chua, L. O., Itoh, M., Kocarev, L. and Eckert, K., "Chaos synchronization in Chua's circuit," *J. of Circuits, Systems, Computers*, vol. 3, no. 1, pp. 93-107, Mar. 1993.
- (10) Johnson, G. A., Tigner, T. E. and Hunt, E. R., "Controlling chaos in Chua's circuit," *ibid.*, pp. 109-117.
- (11) Johnson, G. A. and Hunt, E. R., "Maintaining stability in Chua's circuit driven into regions of oscillation and chaos," *ibid.*, pp. 119-123.
- (12) Murali, K. and Lakshmanan, M., "Controlling chaos in Chua's circuit," *ibid.*, pp. 125-137.
- (13) Chen, G. R. and Dong X. N., "Controlling Chua's circuit," *ibid.*
- (14) Genesio, R. and Tesi, A., "Distortion control of chaotic systems: The Chua's Circuit," *J. of Circuits, Systems and Computers*, vol. 3, no. 1, pp. 151-171, Mar. 1992.
- (15) Hartley, T. and Mossayebi, F., "Control of Chua's circuit," *J. of Circuits, Systems and Computers*, vol. 3, no. 1, pp. 173-194, Mar. 1993.
- (16) Kocarev, L., Halle, K. S., Eckert, K., Chua, L. O. and Parlitz, U., "Experimental demonstration of secure communications via chaotic synchronization," *Int. J. of Bifurcation and Chaos*, vol. 2, no. 4, pp. 709-713, Dec. 1992.
- (17) Parlitz, U., Chua, L. O., Kocarev, L., Halle, K. S. and Shang, A., "Transmission of digital signals by chaotic synchronization," *Int. J. of Bifurcation and Chaos*, vol. 2, no. 4, pp. 973-977, Sep. 1992.
- (18) Anishchenko, V. S., Safonova, M. A. and Chua, L. O., "Stochastic resonance in Chua's circuit," *Int. J. of Bifurcation and Chaos*, vol. 2, no. 2, pp. 397-401, Jun. 1992.
- (19) Halle, K. S., Chua, L. O., Anishchenko, V. S. and Safonova, M. A., "Signal amplification via chaos: Experimental evidence," *Int. J. of Bifurcation and Chaos*, vol. 2, no. 4, pp. 1011-1020, Dec. 1992.
- (20) Kennedy, M. P., "Experimental chaos via Chua's circuit," S. Vohra et al. (Editors), *Proc. of the 1st Experimental chaos conference*, World Scientific, pp. 340-351, 1992.
- (21) Kennedy, M. P., "Robust op amp realization of Chua's circuit," *Frequenz*, vol. 46, no. 34, pp. 66-80, 1992.
- (22) Cruz, J. and Chua, L. O., "A CMOS IC nonlinear resistor for Chua's circuit," *IEEE Trans. Circuits & Syst.*, vol. CAS-39, no. 12, pp. 985-995, 1992.
- (23) Khibnik, A. I., Roose, D. and Chua, L. O., "On periodic orbits and homoclinic bifurcations in Chua's circuit with smooth nonlinearity," in R. N. Madan, *Chua's Circuit: A Paradigm for Chaos*, World Scientific Publishing, Singapore, 1993.
- (24) Brown, R., "From Chua's circuit to the generalized Chua map," *J. of Circuits, Systems and Computers*, vol. 3, no. 1, pp. 11-32, Mar. 1993.
- (25) Misiurewicz, M., "Unimodal interval maps obtained from the modified Chua equations," *Int. J. of Bifurcation and chaos*, vol. 3, no. 2, Apr. 1993.
- (26) V. Perez-Munuzuri, V. Perez-Villar, and Chua, L. O., "Autowaves for image processing on a 2-dimensional CNN array of excitable nonlinear circuits: flat and wrinkled labyrinths," *IEEE Trans. Circuits & Syst.*, vol. CAS-40, no. 3, pp. 174-181, Mar. 1993.
- (27) Zou, F. and Nossek, J. A., "An autonomous chaotic neural network and Chua's circuit," *ibid.*
- (28) Kocarev, L., Karadzinov, L. and Chua, L. O., "N-dimensional canonical Chua's circuit," *ibid.*, pp. 239-258.
- (29) Lukin, K. A., "High frequency oscillation from Chua's circuit," *J. of Circuits, Systems and Computers*, vol. 3, no. 2, Jun. 1992. in press.
- (30) Sharkovsky, A. N., Maistrenko, Y., Deregell, P. and Chua, L. O., "Dry turbulence from a time-delayed Chua's circuit," *J. of Circuits, Systems and Computers*, vol. 3, no. 2, Jun. 1992. in press.
- (31) Shil'nikov, L. P., "Strange attractors and dynamical models," *J. of Circuits, Systems and Computers*, vol. 3, no. 1, pp. 1-10, Mar. 1992.
- (32) Belykh, V. N. and Chua, L. O., "New type of strange attractor from a geometric model of Chua's circuit," *Int. J. of Bifurcation and Chaos*, vol. 2, no. 3, pp. 697-704, Sep. 1992.
- (33) Altman, E. J., "Bifurcation analysis of Chua's circuit with applications for low-level visual sensing," *J. of Circuits, Systems and Computers*, vol. 3, no. 1, pp. 63-92 Mar. 1993.
- (34) Rodet, X., "Sound and music from Chua's circuit," *ibid.*, pp. 49-61.
- (35) Matsumoto, T., Chua, L. O. and Tokunaga, R., "Chaos via torus breakdown," *IEEE Trans. Circuits & Syst.*, vol. CAS-34, no. 3, pp. 240-253, 1987.
- (36) Bartissol, P. and Chua, L. O., "The double hook," *IEEE Trans. Circuits & Syst.*, vol. CAS-35, no. 12, pp. 1212-1522, Dec. 1988.
- (37) Ogorzalek, M. J., "Order and chaos in a third-order RC

- ladder network with nonlinear feedback," *IEEE Trans. Circuits & Syst.*, vol. CAS-36, no. 9, pp. 1221-1230, 1989.
- (38) Nishio, Y., Inaba, N. and Mori, S., "Chaotic phenomena in an autonomous circuit with nonlinear inductor," *ISCAS*, 1990.
 - (39) Nishio, Y., Inaba, N., Mori, S. and Saito, T., "Rigorous analysis of windows in a symmetric circuit," *IEEE Trans. Circuits & Syst.*, vol. CAS-37, no. 4, pp. 473-487, Apr. 1990.
 - (40) Zou, F. and Nossek, J. A., "An autonomous chaotic cellular neural network and Chua's circuit," *J. of Circuits, Systems and Computers*, vol. 3, no. 2, Jun. 1993.
 - (41) Arneodo, A., Coulet, P. and Tresser, C., "Possible new strange attractors with spiral structure," *Communications in Mathematical Physics*, 79, pp. 573-579, 1981.
 - (42) Brockett, R. W., "On conditions leading to chaos in feedback systems," *Proc. CDC*, pp. 932-936, Dec. 1982.
 - (43) Sparrow, C. T., "Chaos in three-dimensional single loop feedback systems with a piecewise-linear feedback function," *J. of Mathematical analysis and applications*, vol. 83, no. 1, pp. 275-291, 1981.
 - (44) Chua, L. O. and Lin, G. N., "Canonical realization of Chua's circuit family," *IEEE Trans. Circuits & Syst.*, vol. CAS-37, no. 7, pp. 885-902, Jul. 1990.
 - (45) Arrowsmith, D. K. and Place, C. M., *An introduction to dynamical systems*, Cambridge University Press, Cambridge, UK, 1990.
 - (46) Hartman, P., *Ordinary Differential Equations*, Birkhauser, Boston, second edition, 1982.
 - (47) Chua, L. O. and Ying, R., "Canonical piecewise-linear analysis," *IEEE Trans. Circuits & Syst.*, vol. CAS-3, no. 3, pp. 125-140, 1983.
 - (48) Parker, T. S. and Chua, L. O., *Practical Numerical Algorithms for Chaotic Systems*, Springer-verlag, New York, 1989.
 - (49) Chua, L. O., *Introduction to Nonlinear Network Theory*, McGraw Hill, New York, 1969.
 - (50) Chua, L. O., Desoer C. A., and Kuh, E. S., *Linear and Nonlinear Circuits*, McGraw Hill, New York, 1987.
 - (51) Chua, L. O. and Ayrom, F., "Designing nonlinear single op-amp circuits: A cookbook approach," *Int. J. Circuit Theory & Appl.*, vol. 13, no. 3, pp. 235-268, Jul. 1985.
 - (52) Chua, L. O. and Wong, S., "Synthesis of piecewise-linear network," *J. on Electronic Circuits and Systems*, vol. 2, no. 4, pp. 102-108, 1978.



Leon O. Chua received the S.M. degree from the Massachusetts Institute of Technology in 1961 and the Ph.D. degree from the University of Illinois, Urbana, in 1964. He was also awarded a Doctor Honoris Causa from the Ecole Polytechnique Federale-Lausanne, Switzerland, in 1983, an Honorary Doctorate from the University of Tokushima, Japan, in 1984, and an HONORARY DOCTORATE (DR.-Ing. E.h.) from the Technische Universität Dresden in 1992. He is presently a professor of Electrical Engineering and Computer Sciences at the University of California, Berkeley. Professor Chua's research interests are in the areas of general nonlinear network and system theory. He has been a consultant to various electronic industries in the areas of nonlinear network analysis, modeling, and computer-aided design. He is the author of *Introduction to Nonlinear Network Theory* (New York: McGraw-Hill, 1969), and a coauthor of the books *Computer-Aided Analysis of Electronic Circuits: Algorithms and Computational Techniques* (Englewood Cliffs, NJ: Prentice-Hall, 1975), *Linear and Nonlinear Circuits* (New York: McGraw-Hill, 1987), and *Practical Numerical Algorithms for Chaotic Systems* (New York: Springer-Verlag, 1989). He has published many research papers in the area of nonlinear networks and systems. Professor Chua was elected Fellow of the IEEE in 1974. He served as Editor of the IEEE Transactions on Circuits and Systems from 1973 to 1975 and as the President of the IEEE Society on Circuits and Systems in 1976. He is presently the editor of the *International Journal of Bifurcation and Chaos*, a deputy editor of the *International Journal of Circuit Theory and Applications*, and the Editor of the *World Scientific Book Series on Nonlinear Science*. Professor Chua is the holder of five U.S. patents. He is also the recipient of several awards and prizes, including the 1967 IEEE Browder J. Thompson Memorial Prize Award, the 1973 IEEE W.R.G. Baker Prize Award, the 1974 Frederick Emmons Terman Award, the 1976 Miller Research Professorship from the Miller Institute, the 1982 Senior Visiting Fellowship at Cambridge University, England, the 1982/83 Alexander von Humboldt Senior U.S. Scientist Award at the Technical University of Munich, W. Germany, the 1983/84 Visiting U.S. Scientist Award at Waseda University, Tokyo, from the Japan Society for Promotion of Science, the IEEE Centennial Medal in 1985, the 1985 Myril B. Reed Best Paper Prize, the 1985 and 1989 IEEE Cuillemin-Cauer Prize, and the 1993 IEEE CAS Technical Achievement Prize. In the fall of 1986, Professor Chua was awarded a Professor Invité International Award at the University of Paris-Sud from the French Ministry of Education. In the summer of 1993, he was awarded a Fellowship from the Département de Mathématique, Université de Nice.